

A

EXTRAKCE A CHIRURGIE
EXTRACTION AND SURGERY

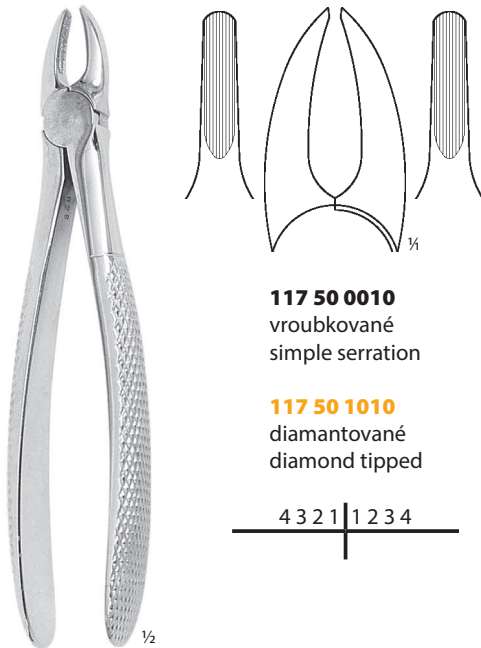

Kleště extrakční	Extraction Forceps	11–15
Kleště štípací	Bone Rongeurs	16–18
Kleště úchopné	Grasping Forceps	19
Páčidla	Elevators	20
Páky extrakční	Root Elevators	21–25
Škrabky	Raspatories	26
Pilníky	Rasps	27
Dláta	Chisels	28–29
Kladívka	Mallets	30
Háky	Hooks, Retractors	31–36
Chrániče prstu	Finger Protectors	36
Rozvěrače úst	Mouth Retractors	37
Lžičky	Bone Curettes, Spoons	38–40
Nástroje řezné	Cutting Instruments	40–41
Držátka skalpelových čepelk	Scalpel Handles	42
Skalpelové čepelky	Scalpel Blades	43
Svorky	Clamps, Forceps	44–49
Jehelce	Needle Holders	50–53
Zavaděče	Introducers	54
Dlahy dentální	Dental Plates	54
Nůžky	Scissors	55–63
Pinzety	Forceps	64–70



117 50 0010
vroubkované
simple serration

117 50 1010
diamantované
diamond tipped

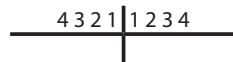

D2
na horní malé řezáky
for upper laterals
16,8 cm



117 50 0020
vroubkované
simple serration

117 50 1020
diamantované
diamond tipped



D7
na horní premoláry
for upper premolars
16,4 cm

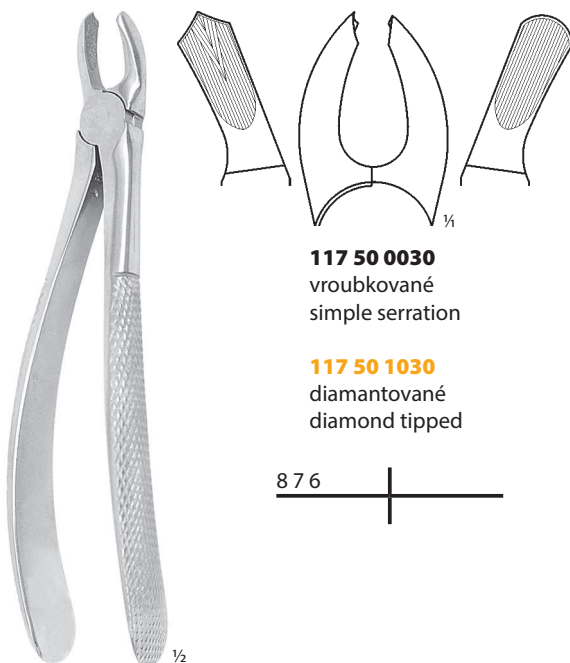

117 50 0030
vroubkované
simple serration

117 50 1030
diamantované
diamond tipped



D17
na horní moláry pravé
for right upper molars
17,2 cm

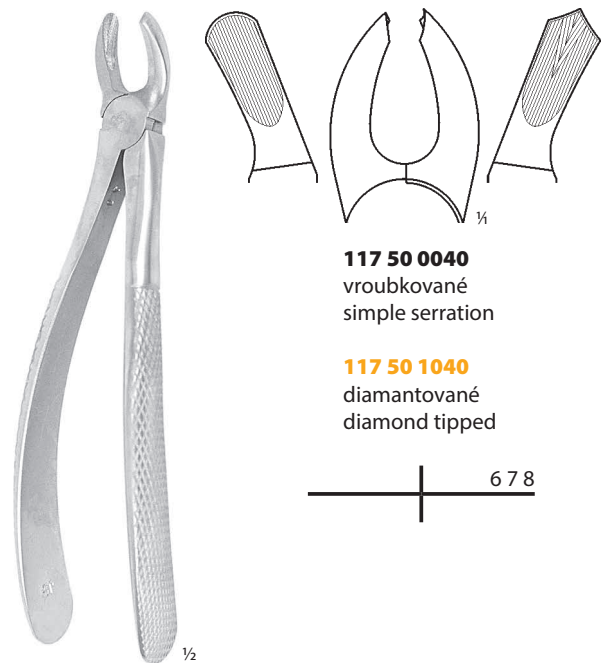

117 50 0040
vroubkované
simple serration

117 50 1040
diamantované
diamond tipped



D18
na horní moláry levé
for left upper molars
17,2 cm

KLEŠTĚ EXTRAKČNÍ
EXTRACTION FORCEPS

117 50 0150
vroubkované
simple serration

117 50 1150
diamantované
diamond tipped

6 5 4 3 2 1 | 1 2 3 4 5 6

D13
na dolní premoláry
for lower premolars
15,0 cm



117 50 0160
vroubkované
simple serration

117 50 1160
diamantované
diamond tipped

7 6 | 6 7

D22
na dolní moláry
for lower molars
15,0 cm



117 50 0200
vroubkované
simple serration

117 50 1200
diamantované
diamond tipped

8 7 6 5 4 3 2 1 | 1 2 3 4 5 6 7 8

D33
na dolní kořeny široké
for lower roots broad
14,8 cm



117 50 0190
vroubkované
simple serration

117 50 1190
diamantované
diamond tipped

8 7 6 5 4 3 2 1 | 1 2 3 4 5 6 7 8

D33A
na dolní kořeny úzké
for lower roots
14,8 cm



117 50 0060
vroubkované
simple serration

117 50 1060
diamantované
diamond tipped

5 4 3 2 1 | 1 2 3 4 5

D30S
na horní kořeny
for upper roots
15,0 cm

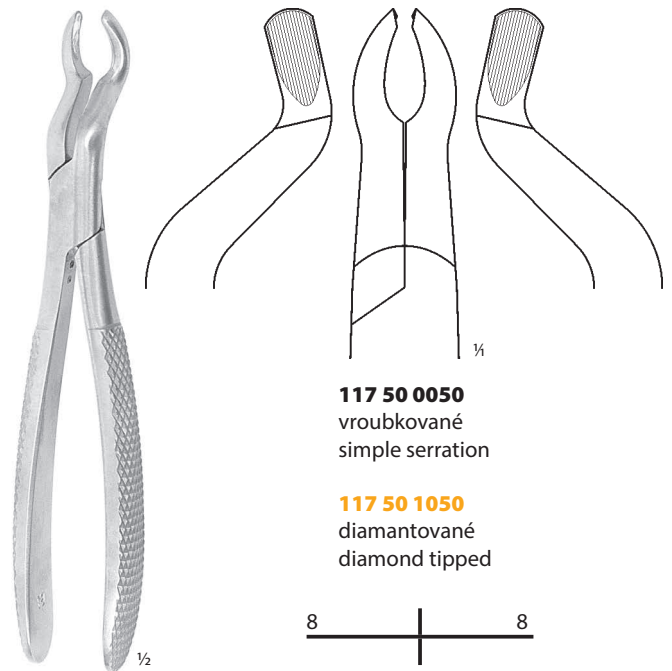

117 50 0050
vroubkované
simple serration

117 50 1050
diamantované
diamond tipped

8 | 8

D67
na horní 3. moláry
for upper wisdoms
17,4 cm



117 50 0250
vroubkované
simple serration

117 50 1250
diamantované
diamond tipped

87654321 | 12345678

D51A
bajonetové úzké
for upper roots narrow
18,2 cm

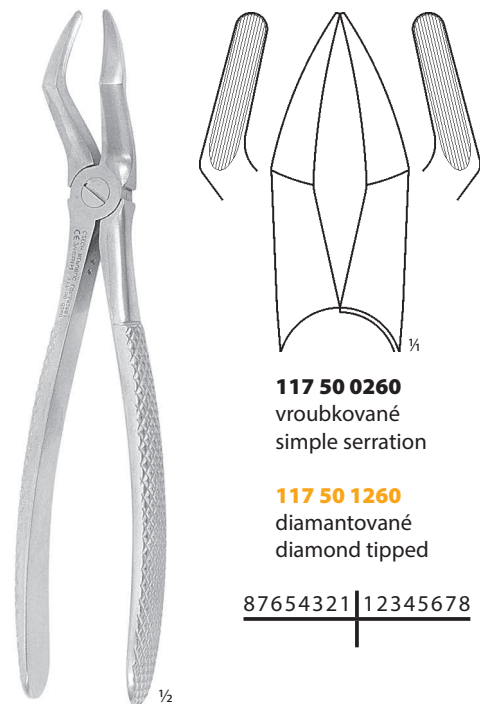

117 50 0260
vroubkované
simple serration

117 50 1260
diamantované
diamond tipped

87654321 | 12345678

D51
bajonetové široké
for upper roots broad
18,2 cm

KLEŠTĚ EXTRAKČNÍ
EXTRACTION FORCEPS

117 50 0170
vroubkované
simple serration

117 50 1170
diamantované
diamond tipped



D73
na dolní moláry
for lower molars
15,0 cm



117 50 0350
vroubkované
simple serration

117 50 1350
diamantované
diamond tipped

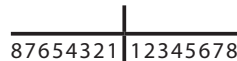

D74
na dolní kořeny
for lower roots
15,0 cm

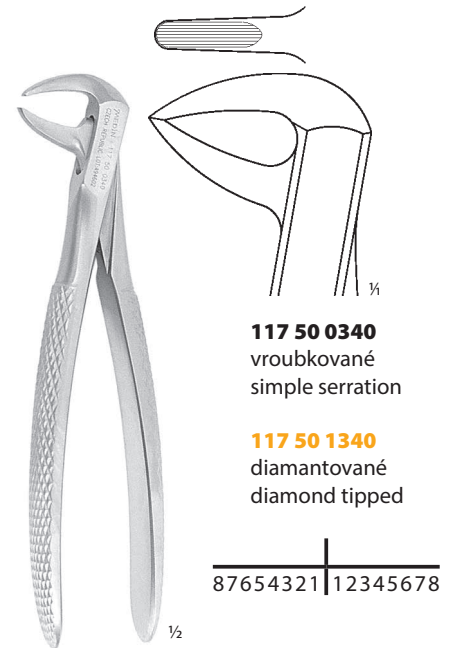

117 50 0340
vroubkované
simple serration

117 50 1340
diamantované
diamond tipped



D74M
na dolní kořeny
for lower roots
15,0 cm



117 50 0330
vroubkované
simple serration

117 50 1330
diamantované
diamond tipped



D74N
na dolní kořeny
for lower roots
15,0 cm

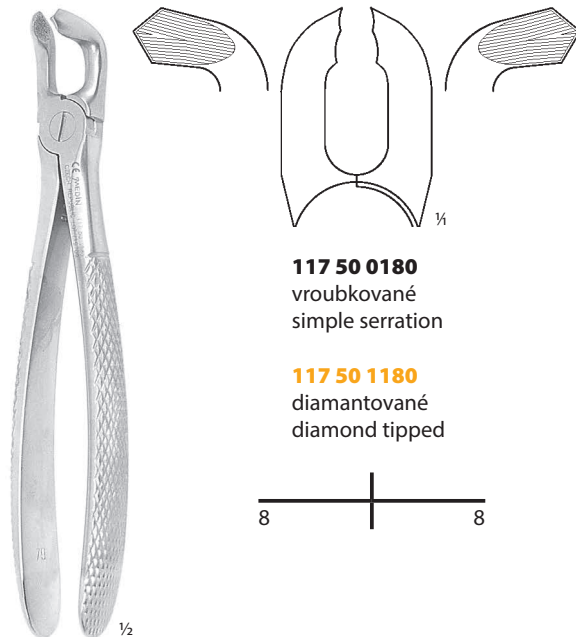

117 50 0180
vroubkované
simple serration

117 50 1180
diamantované
diamond tipped



D79
na dolní 3. moláry
for lower wisdoms
16,5 cm

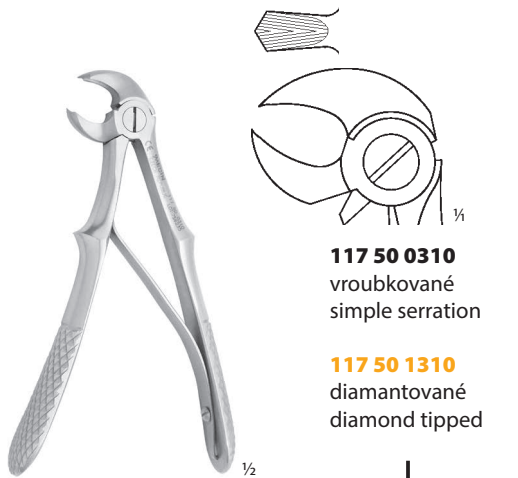

D339
na dolní moláry
for lower molars
10,7 cm



D342
na horní moláry
for upper molars
11,7 cm

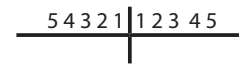

KLEŠTĚ K ODSTRANĚNÍ KOŘENOVÝCH NÁSTROJŮ
FORCEPS FOR EXTRACTION OF ROOT INSTRUMENTS



117 51 0600
rovné
straight
13,5 cm



117 51 1600
rovné, diamantované
straight, diamond tipped
13,5 cm



117 51 0610
zahnuté
curved
13,5 cm



117 51 1610
zahnuté, diamantované
curved, diamond tipped
13,5 cm

KLEŠTĚ ŠTÍPACÍ
BONE RONGEURS

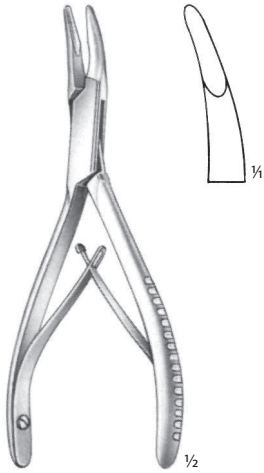

MINI-FRIEDMAN
116 91 0017
12,0 cm

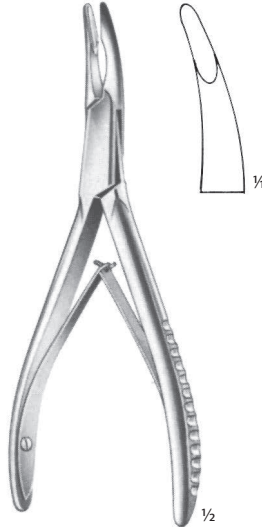

FRIEDMAN
116 91 0514
14,0 cm

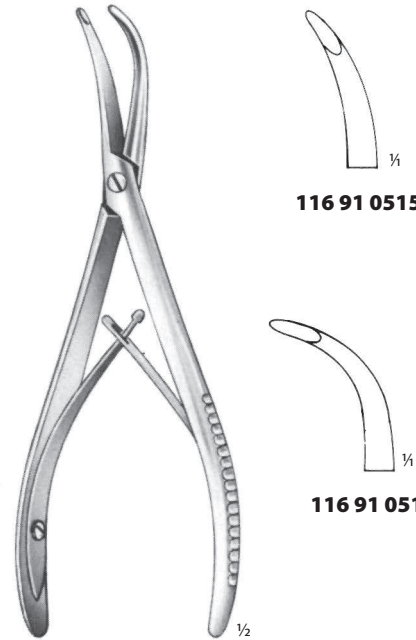

STELLBRINK
17,0 cm

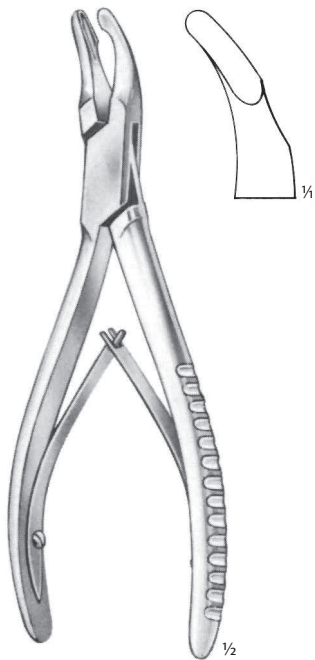

CLEVELAND
116 91 0518
17,0 cm

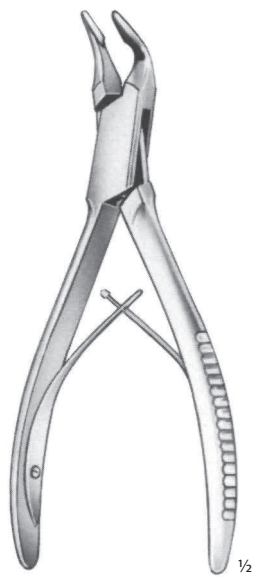

BLUMENTHAL
15,5 cm

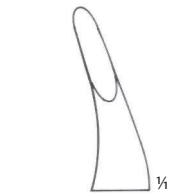

116 91 0522

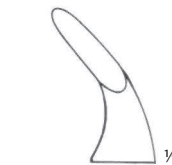

116 91 0523

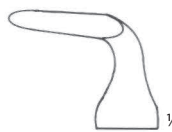

116 91 0524

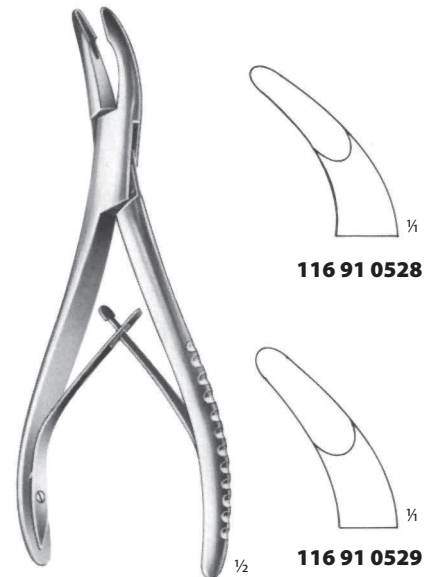

LUER
15,0 cm



116 91 0527

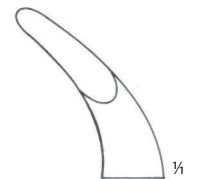

116 91 0528

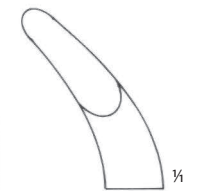

116 91 0529



LUER
116 08 0030
rovné
straight
17,0 cm

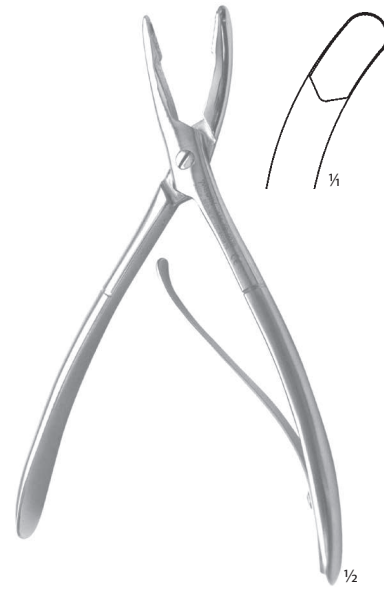

LUER
116 08 0070
zahnuté
curved
15,0 cm

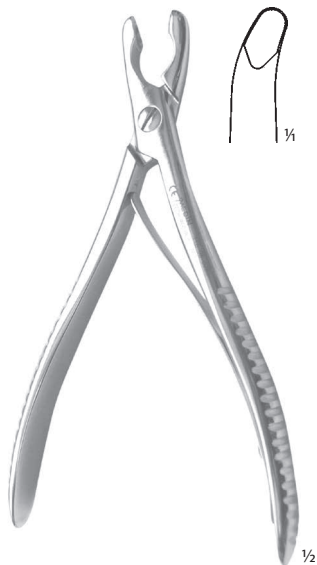

LUER
116 08 0080
zahnuté
curved
14,5 cm



JANSEN
116 29 0410
zahnuté
curved
18,0 cm
Fig. 2

KLEŠTĚ ŠTÍPACÍ
BONE RONGEURS

116 08 0280
rovné
straight
14,0 cm

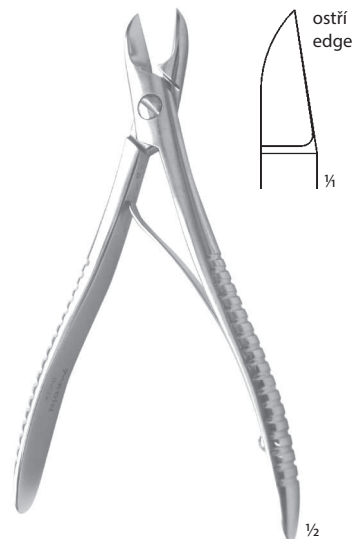

LISTON
116 08 0410
rovné
straight
14,0 cm

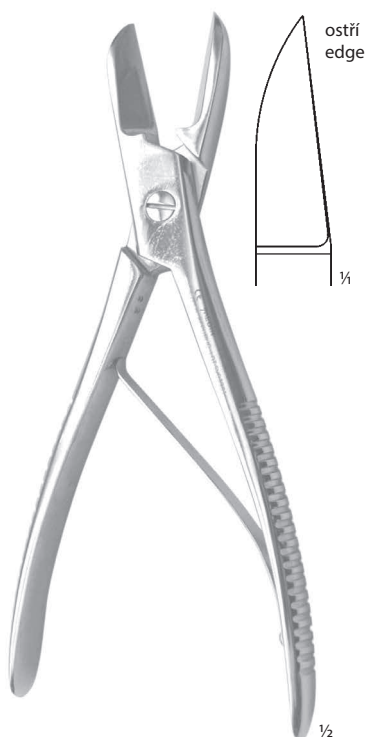

LISTON
116 08 0440
rovné
straight
19,0 cm

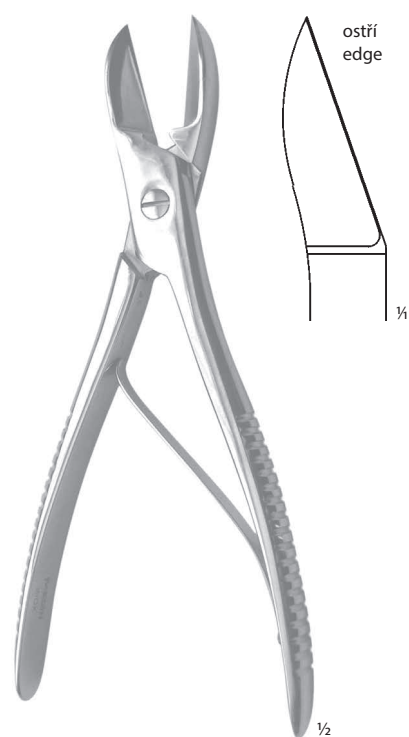

LISTON
116 08 0450
zahnuté
curved
19,0 cm

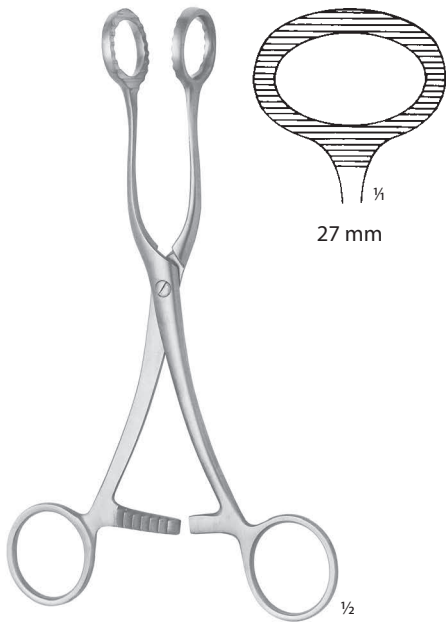

COLLIN
117 31 0010
16,7 cm

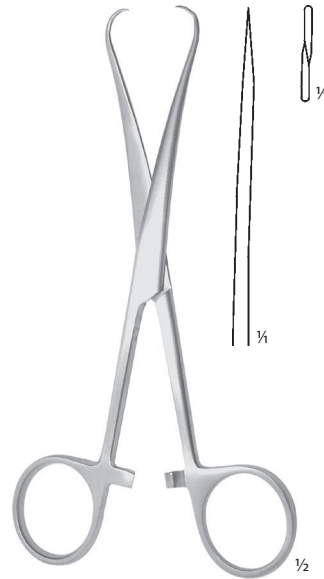

LÖBKER
117 31 0030
15,0 cm

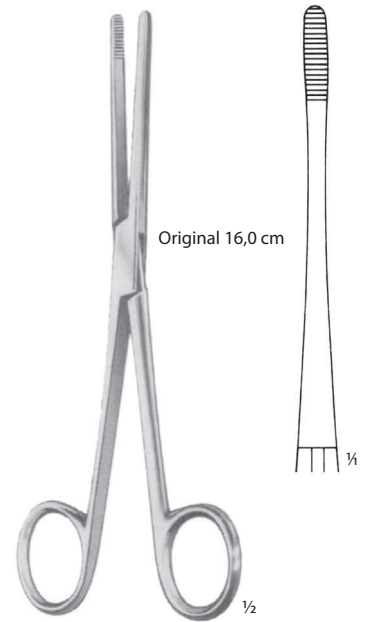

LISTER
117 91 0001 13,0 cm
117 91 0002 16,0 cm
117 91 0003 18,0 cm

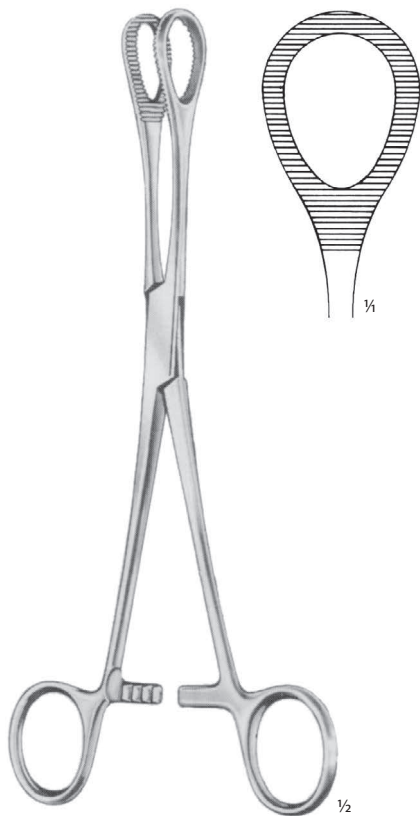

HEYWOOD-SMITH
117 91 0038
21,0 cm



HEYWOOD-SMITH
117 91 0039
25,0 cm



COLLIN
117 91 0033
24,0 cm

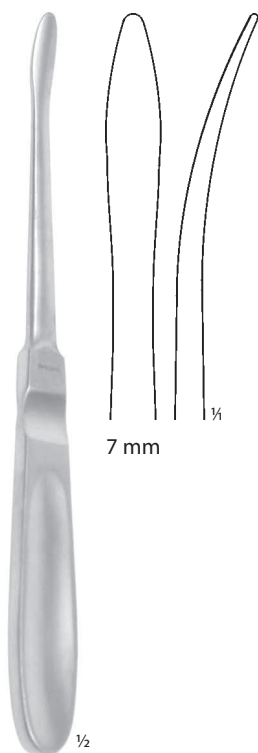

LANGENBECK
123 08 0010
19,5 cm
Fig. 1

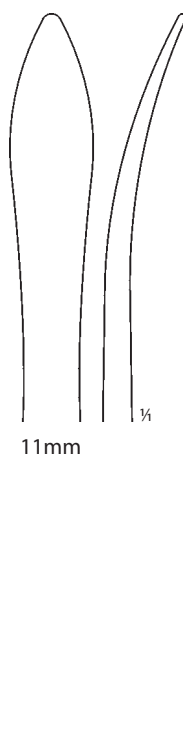

LANGENBECK
123 08 0020
19,5 cm
Fig. 2

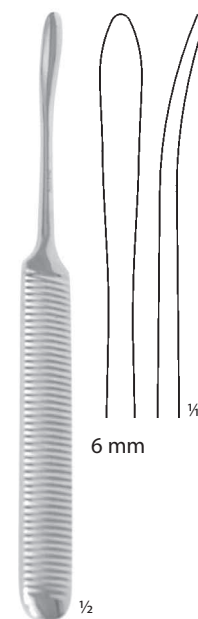

WILLIGER
123 08 0030
16,0 cm
Fig. 1

PÁČIDLA NOSNÍ
NASAL ELEVATORS



FREER
123 30 0030
17,9 cm

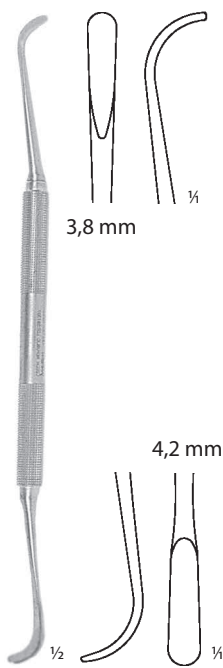

123 99 0084
17,0 cm



FREER
19,0 cm

123 91 0006
ostré
sharp

123 91 0007
tupé
blunt



FREER
123 91 0008
18,0 cm

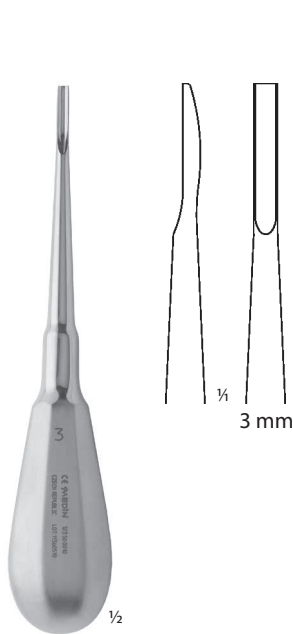

BEIN
123 50 0010
rovná
straight
14,5 cm



BEIN
123 50 0011
rovná
straight
16,5 cm

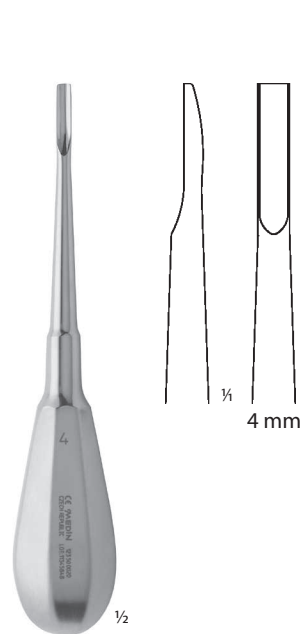

BEIN
123 50 0020
rovná
straight
14,5 cm



BEIN
123 50 0021
rovná
straight
16,5 cm

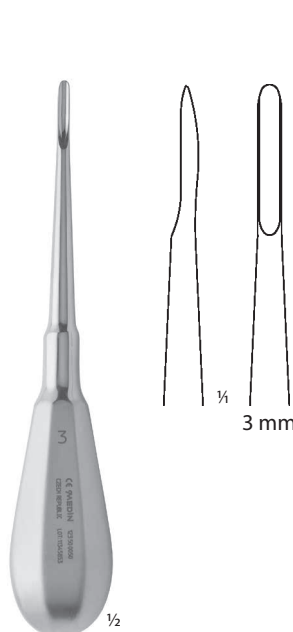

BEIN
123 50 0050
oblouková
embowed
14,5 cm



BEIN
123 50 0051
oblouková
embowed
16,5 cm

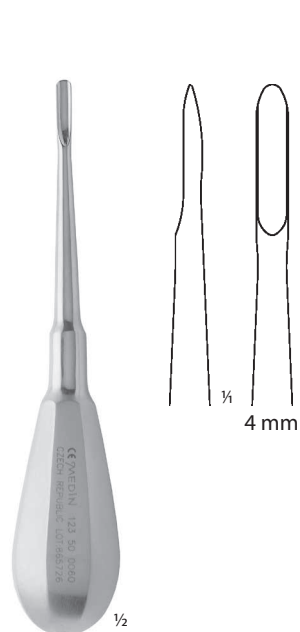

BEIN
123 50 0060
oblouková
embowed
14,5 cm

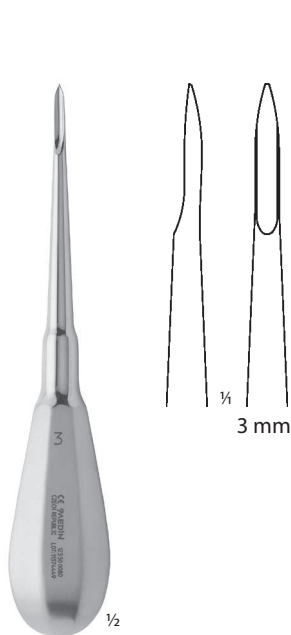

BEIN
123 50 0061
oblouková
embowed
16,5 cm

PÁKY EXTRAKČNÍ
ROOT ELEVATORS

BEIN
123 50 0080
rovná, jemná
straight, fine
14,5 cm



BEIN
123 50 0081
rovná, jemná
straight, fine
16,5 cm

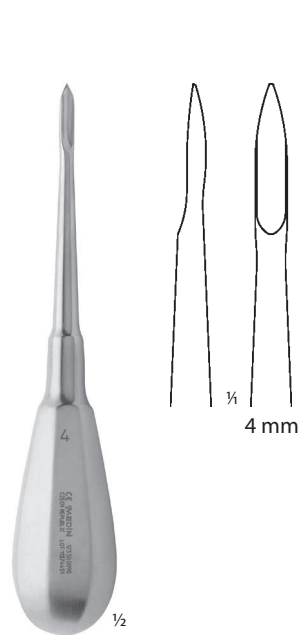

BEIN
123 50 0090
rovná, jemná
straight, fine
14,5 cm



BEIN
123 50 0091
rovná, jemná
straight, fine
16,5 cm

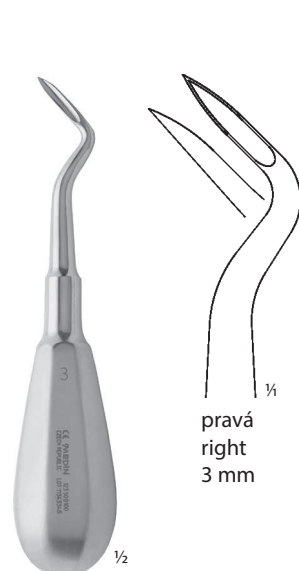

FLOHR
123 50 0100
hrotnatá, ostrá
pointed, sharp
13,0 cm



FLOHR
123 50 0101
hrotnatá, ostrá
pointed, sharp
15,0 cm

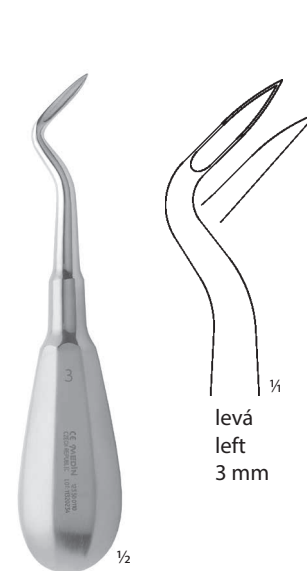

FLOHR
123 50 0110
hrotnatá, ostrá
pointed, sharp
13,0 cm



FLOHR
123 50 0111
hrotnatá, ostrá
pointed, sharp
15,0 cm

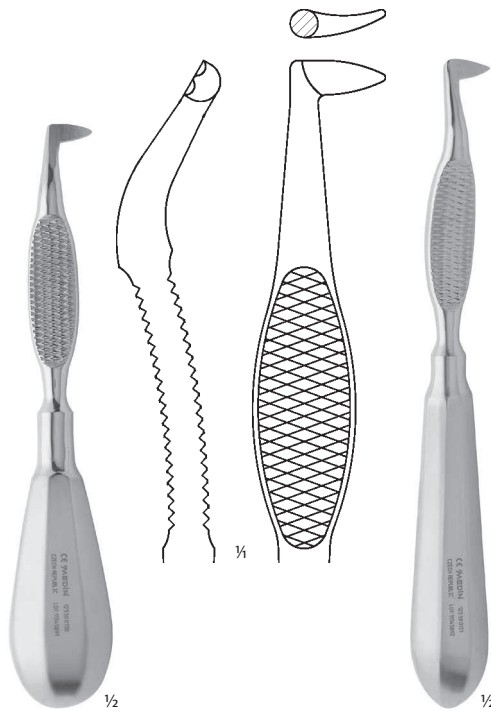

SCHLEMMER
123 50 0130
pravá
right
15,1 cm



SCHLEMMER
123 50 0131
pravá
right
17,1 cm

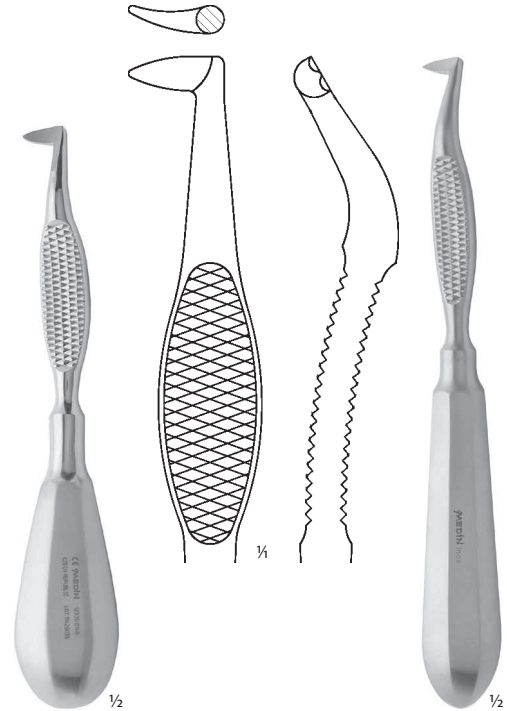

SCHLEMMER
123 50 0140
levá
left
15,1 cm



SCHLEMMER
123 50 0141
levá
left
17,1 cm

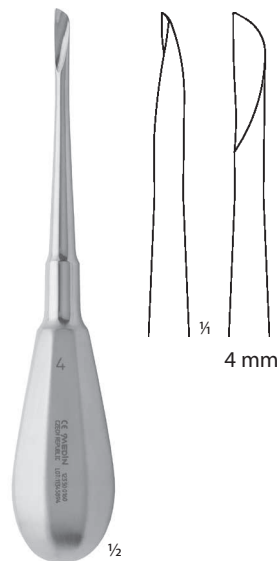

123 50 0160
rovná, pravá
straight, right
14,5 cm

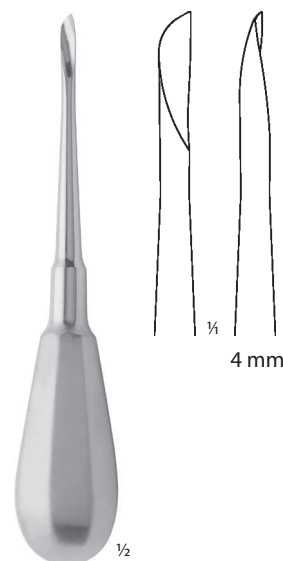

123 50 0170
rovná, levá
straight, left
14,5 cm

PÁKY EXTRAKČNÍ
ROOT ELEVATORS

ŠPINAR
123 50 0210
přední
frontal
14,8 cm

ŠPINAR
123 50 0211
přední
frontal
16,8 cm

ŠPINAR
123 50 0220
zadní
retal
14,8 cm

ŠPINAR
123 50 0221
zadní
retal
16,8 cm

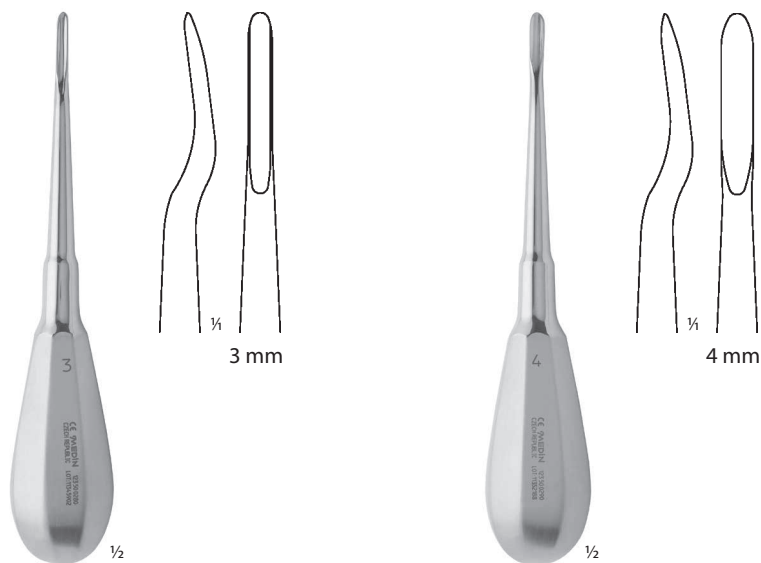

WHITE
123 50 0280
oblouková, vyhnutá
embowed, angled
14,5 cm

WHITE
123 50 0290
oblouková, vyhnutá
embowed, angled
14,5 cm

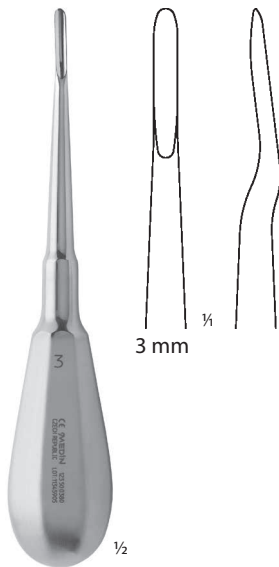

WHITE
123 50 0380
oblouková, vyhnutá
embowed, angled
14,5 cm

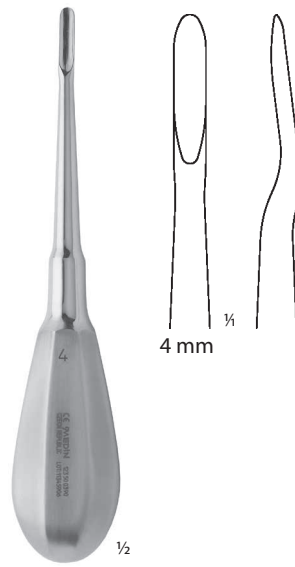

WHITE
123 50 0390
oblouková, vyhnutá
embowed, angled
14,5 cm

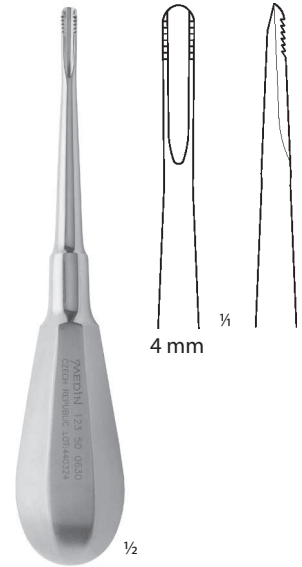

123 50 0630
se zuby, rovná
with saw, straight
14,5 cm

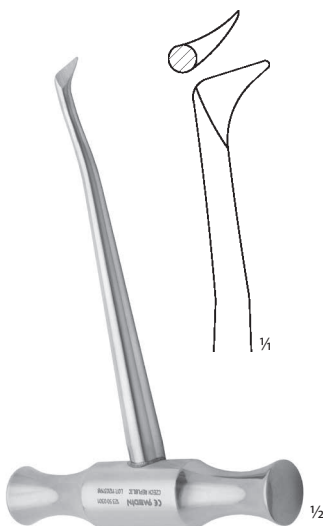

BARRY
123 50 0301
pravá
right
12,4 cm

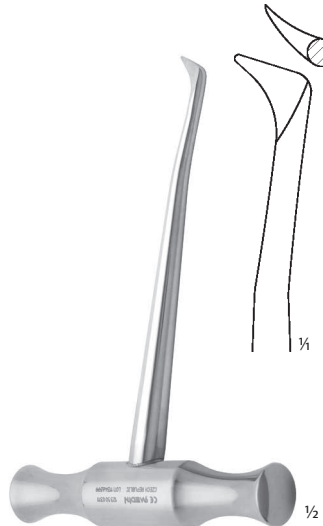

BARRY
123 50 0311
levá
left
12,4 cm

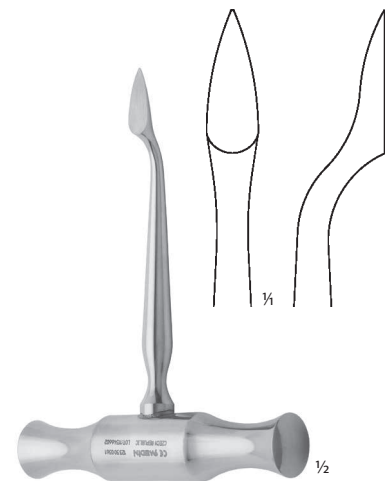

LECLUSE
123 50 0361
10,8 cm

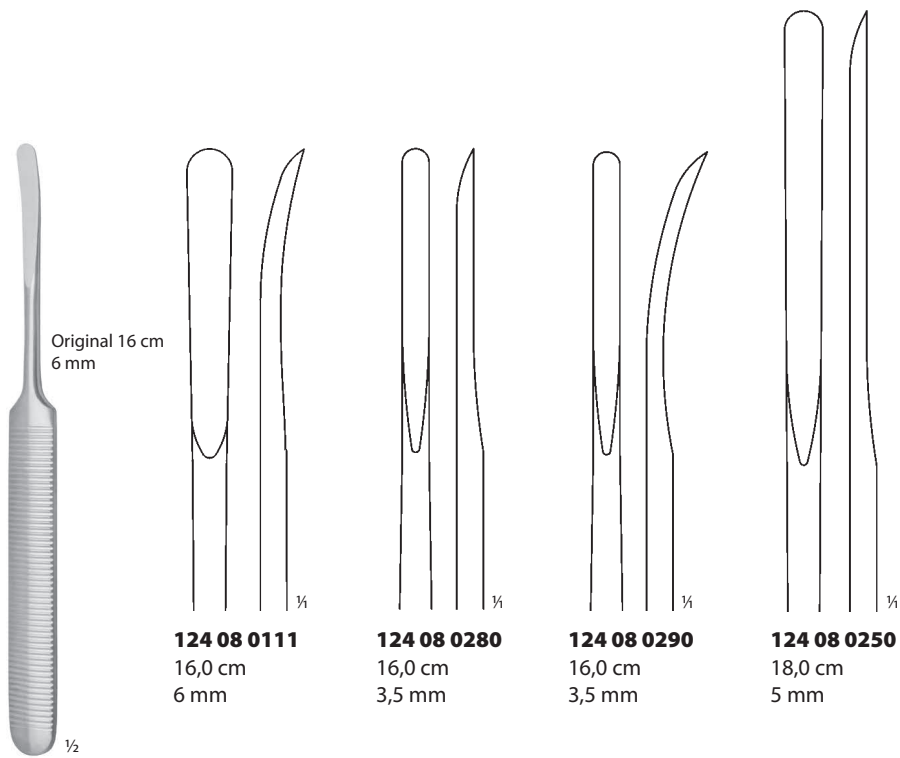

WILLIGER
16,0 cm

124 08 0111
16,0 cm
6 mm

124 08 0280
16,0 cm
3,5 mm

124 08 0290
16,0 cm
3,5 mm

124 08 0250
18,0 cm
5 mm

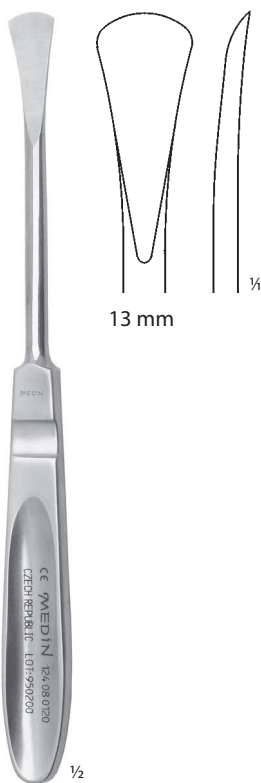

LANGENBECK
124 08 0120
20,5 cm

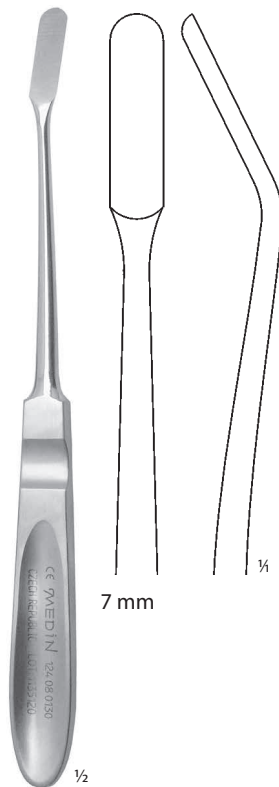

LANGENBECK
124 08 0130
20,4 cm

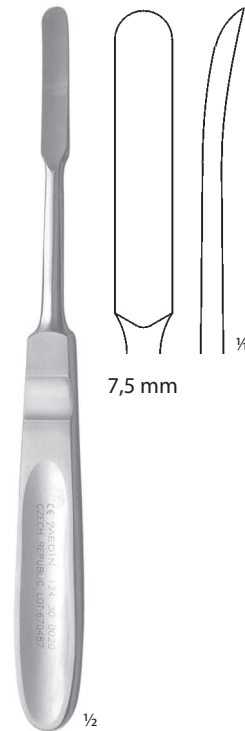

PŘECEHTĚL
124 30 0020
19,0 cm

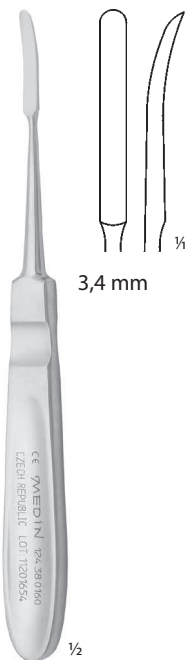

124 38 0160
17,2 cm

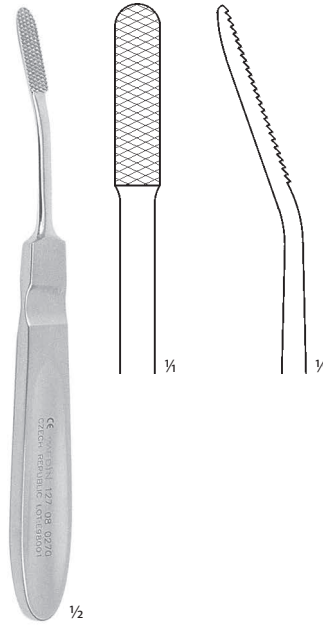

127 08 0270
15,9 cm

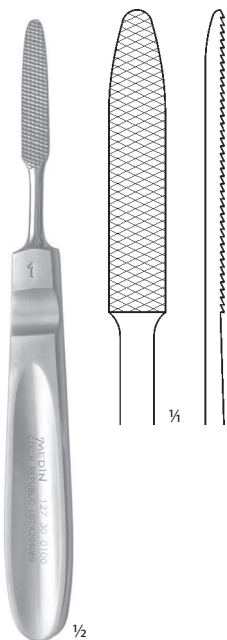

JOSEPH
127 30 0100
16,5 cm
Fig. 1

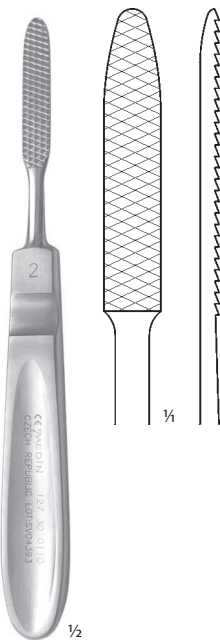

JOSEPH
127 30 0110
16,5 cm
Fig. 2

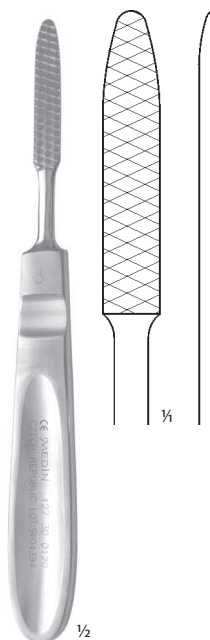

JOSEPH
127 30 0120
16,5 cm
Fig. 3

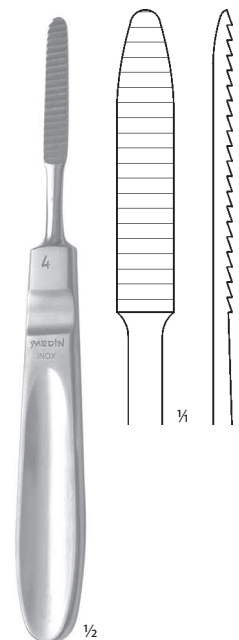

JOSEPH
127 30 0130
16,5 cm
Fig. 4

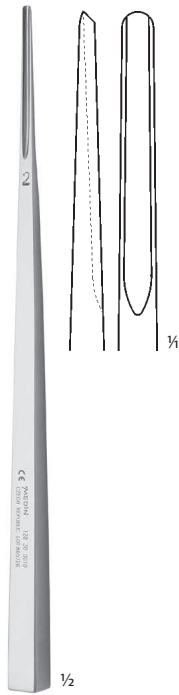

128 30 0010
18,0 cm
2 mm

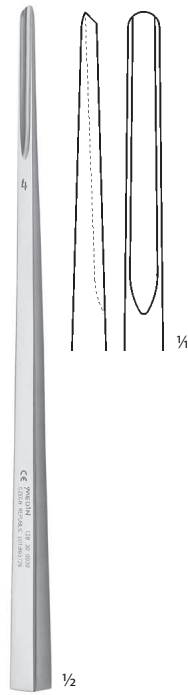

128 30 0030
18,0 cm
4 mm

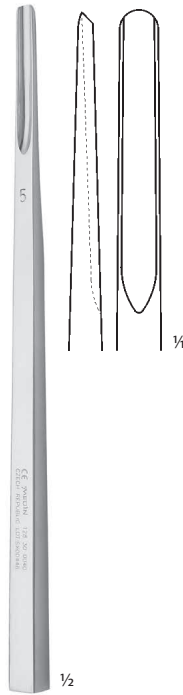

128 30 0040
18,0 cm
5 mm

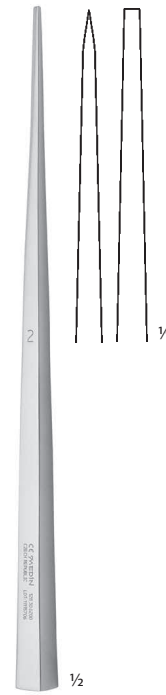

WEST
128 30 0200
18,0 cm
2 mm

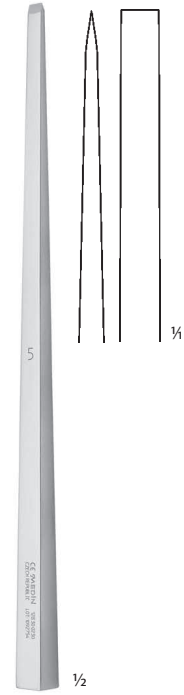

WEST
128 30 0230
18,0 cm
5 mm

DLÁTA JEMNÁ
CHISELS FINE

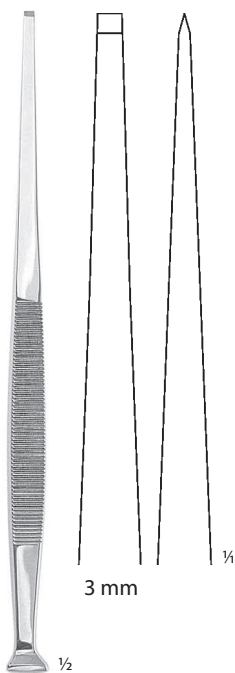

128 50 0050
ploché
flat
17,5 cm

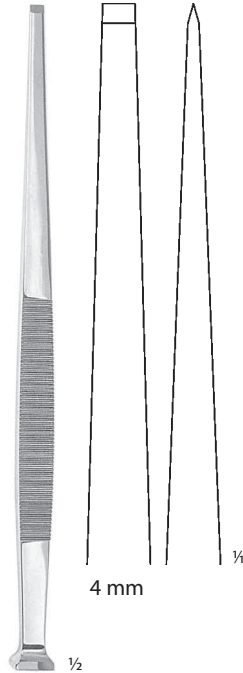

128 50 0060
ploché
flat
17,5 cm

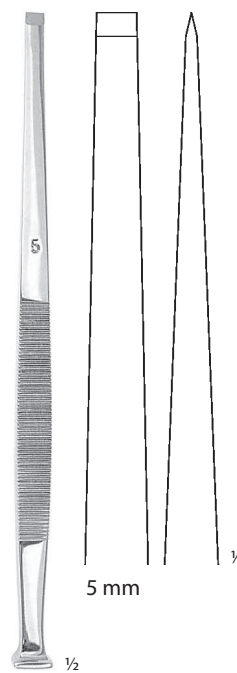

128 50 0070
ploché
flat
17,5 cm

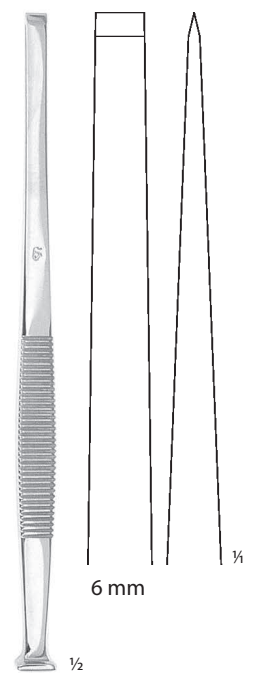

128 50 0080
ploché
flat
17,5 cm

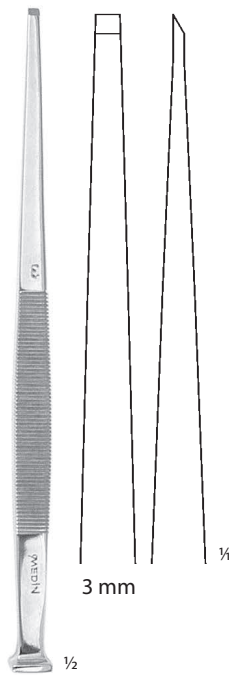

128 50 0110
poloklínové
half-wedged
17,5 cm

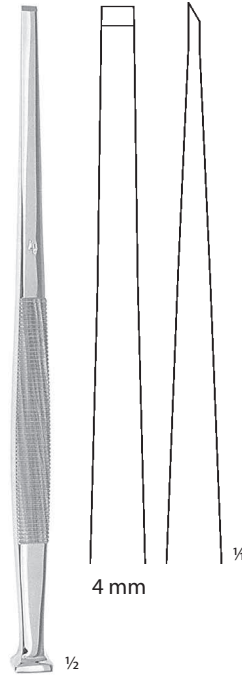

128 50 0120
poloklínové
half-wedged
17,5 cm

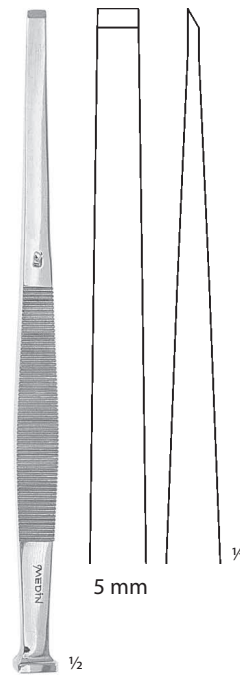

128 50 0130
poloklínové
half-wedged
17,5 cm

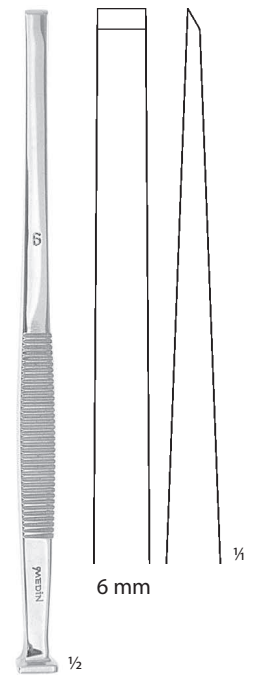

128 50 0140
poloklínové
half-wedged
17,5 cm

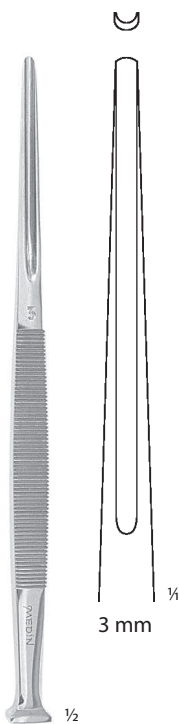

128 50 0200
žlábkové
grooved
17,5 cm

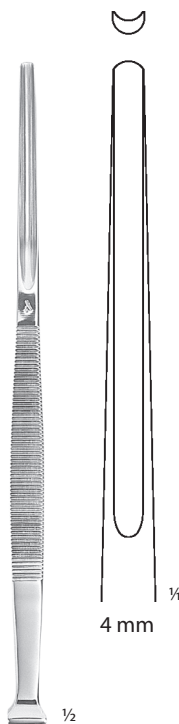

128 50 0210
žlábkové
grooved
17,5 cm

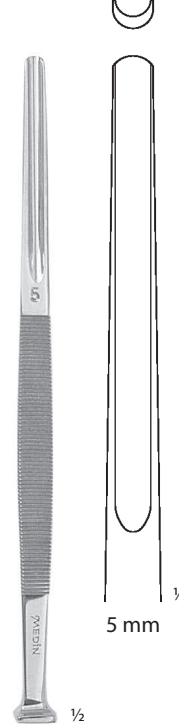

128 50 0220
žlábkové
grooved
17,5 cm

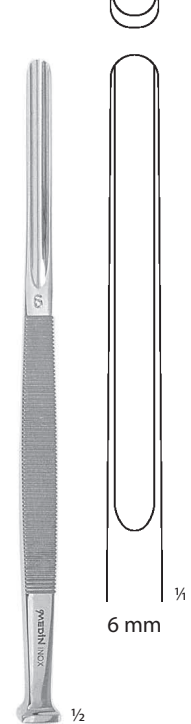

128 50 0230
žlábkové
grooved
17,5 cm



Kladívko chirurgické
Surgical mallet
128 08 0901
250 g
22,3 cm



Kladívko chirurgické
Surgical mallet
128 08 0911
500 g
23,5 cm



118 91 0027
16,0 cm



118 08 0010



118 08 0050



118 08 0020

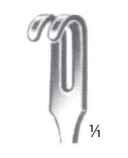

118 08 0060



118 91 0027



118 91 0035



118 91 0028
ostrý
sharp



118 91 0036
tupý
blunt



118 91 0046
ohýbný
flexible
16,0 cm



118 91 0045



118 91 0048



118 91 0046



118 91 0049

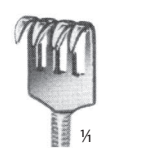

118 91 0047
ostrý
sharp

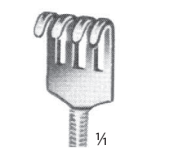

118 91 0050
tupý
blunt



JOSEPH
118 91 0051
16,0 cm



JOSEPH
118 91 0052
16,0 cm



118 91 0052
2,0 mm



118 91 0053
5,0 mm



118 91 0054
7,0 mm

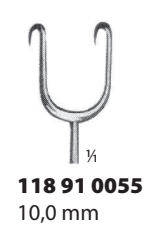

118 91 0055
10,0 mm

HÁKY JEMNÉ
DELICATE HOOKS



DESMARRES
13,0 cm



118 38 0020
12 mm



118 91 0077
16 mm



118 38 0010
10 mm



118 38 0030
14 mm



118 91 0078
18 mm

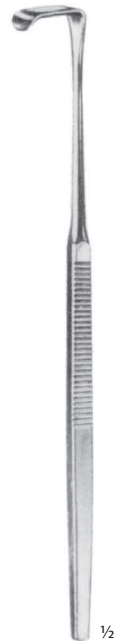

MINI-LANGENBECK
16,0 cm



118 91 0069



118 91 0070



118 91 0071



118 91 0072



CUSHING
20,0 cm



118 91 0085
8 mm



118 91 0087
12 mm



118 91 0089
16 mm



118 91 0086
10 mm



118 91 0088
14 mm



118 91 0090
18 mm



CUSHING
24,0 cm



118 91 0091
8 mm



118 91 0093
12 mm



118 91 0095
16 mm



118 91 0092
10 mm



118 91 0094
14 mm



118 91 0096
18 mm



118 12 0010
16,0 cm

118 12 0010
Fig. 1



118 12 0020
Fig. 2



118 12 0050
16,0 cm

118 12 0050
5,0 mm



118 12 0060
5,0 mm



118 38 0210
13,5 cm

118 38 0210
2,6 mm



118 38 0220
3,2 mm



118 38 0230
4,0 mm

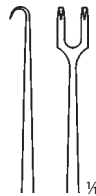

118 38 0360
14,5 cm

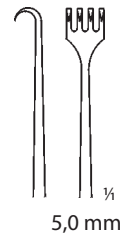

HÁKY NA RÁNY
RETRACTORS

MIDDELDORPF
118 08 0650



118 08 0650
14 × 12 mm
22,0 cm



118 08 0660
21 × 21 mm
22,0 cm



118 08 0670
32 × 31 mm
23,5 cm



118 08 0680
62 × 50 mm
28,0 cm

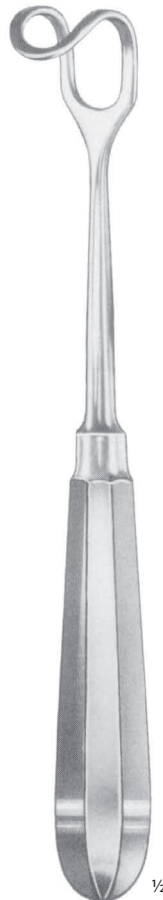

MIDDELDORPF
118 91 0208



118 91 0208
14 × 17 mm
21,5 cm



118 91 0209
20 × 22 mm
22,0 cm



118 91 0210
26 × 30 mm
23,5 cm

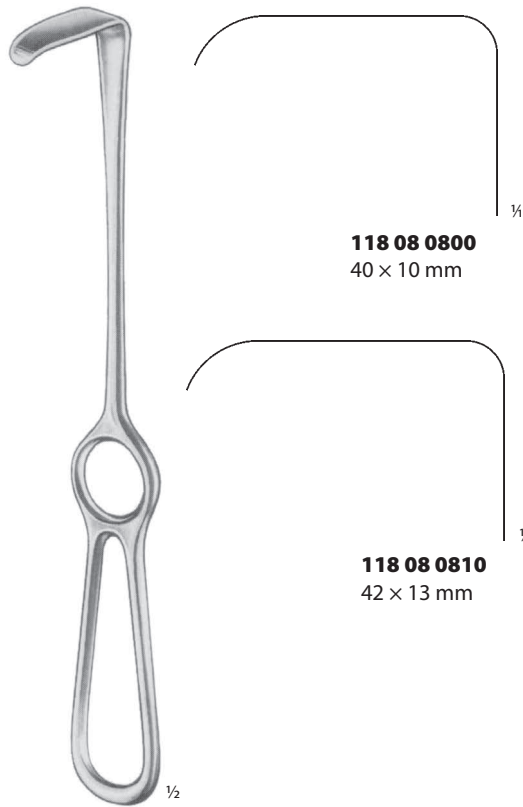

LANGENBECK
21,0 cm

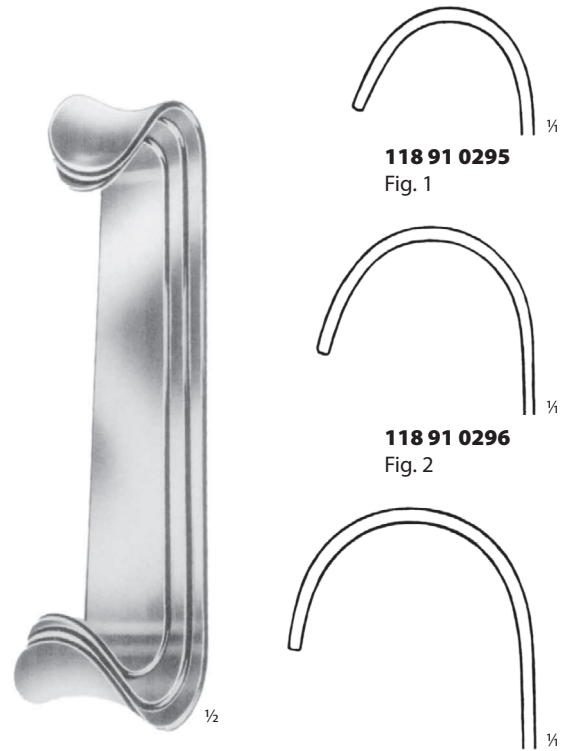

ROUX
118 91 0294
sada (Fig. 1+2+3)
set (Fig. 1+2+3)
16,5 cm

118 91 0297
Fig. 3

HÁKY RESEKČNÍ
RESECTION HOOKS

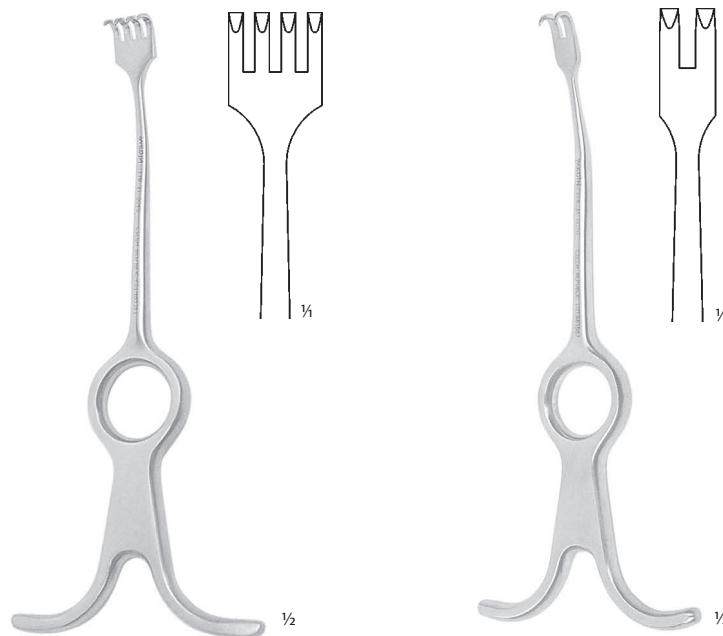

118 31 0040
rovný
straight
16,4 cm

118 31 0070
rovný
straight
16,4 cm

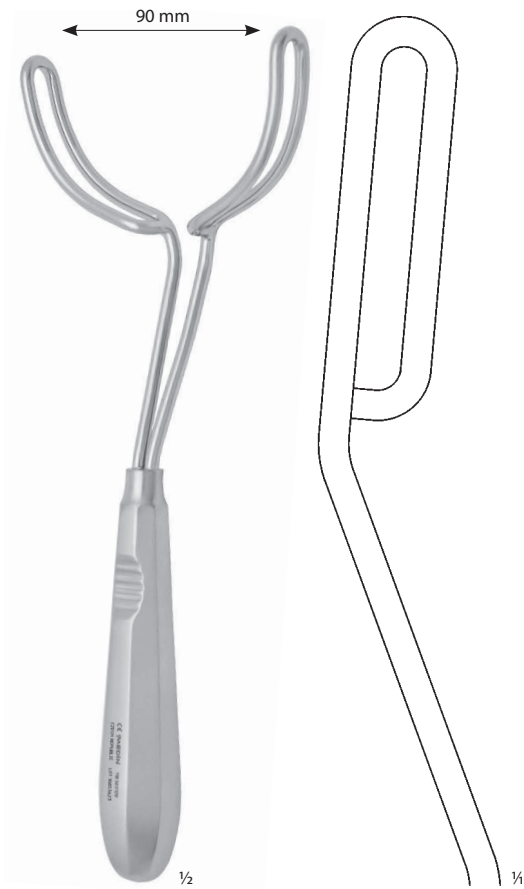
HÁK INTRAORÁLNÍ
INTRAORAL HOOK

118 50 0120
22,9 cm

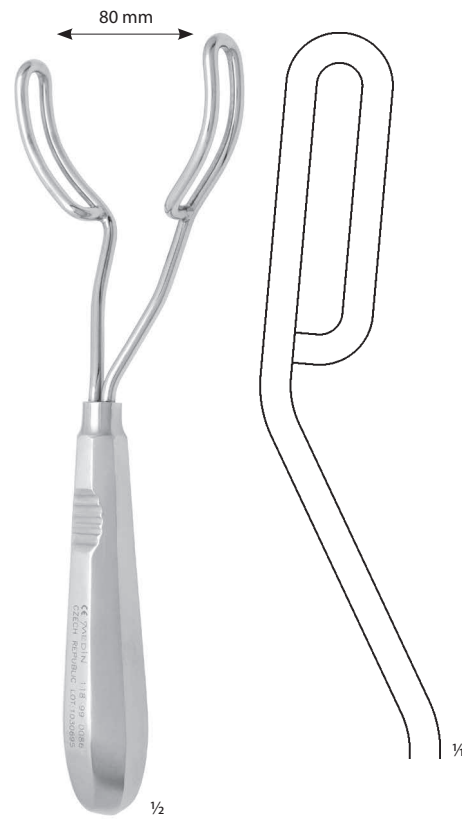

118 99 0086
20,8 cm

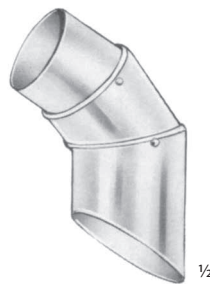
CHRÁNIČE PRSTU
FINGER PROTECTORS

LANGENBECK

	Ø
136 91 0001	2,20 cm
136 91 0002	2,45 cm
136 91 0003	2,65 cm



ROSER-KÖNIG
119 07 0010
19,5 cm

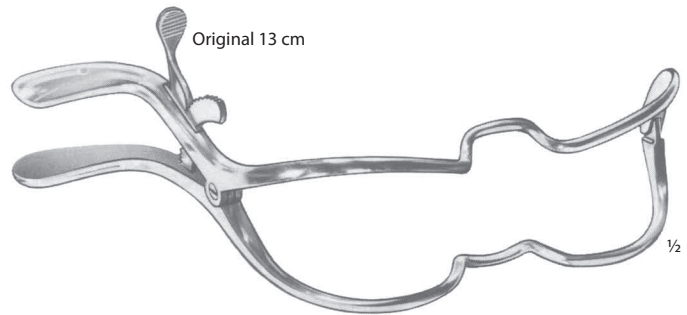

JENNINGS
119 91 0185 9,0 cm
119 91 0186 11,0 cm
119 91 0187 13,0 cm
119 91 0188 15,0 cm

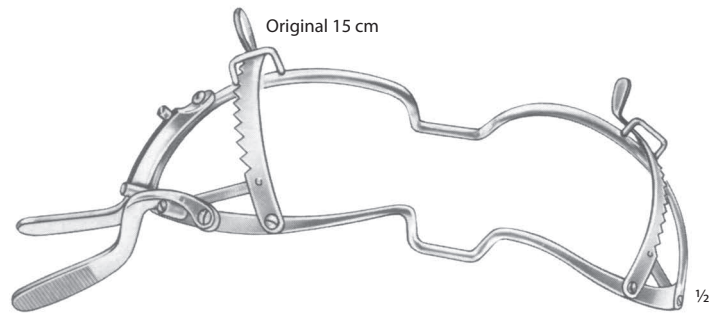

WHITEHEAD
119 91 0190 11,0 cm
119 91 0191 13,0 cm
119 91 0192 15,0 cm



HEISTER
119 07 0020
13,0 cm

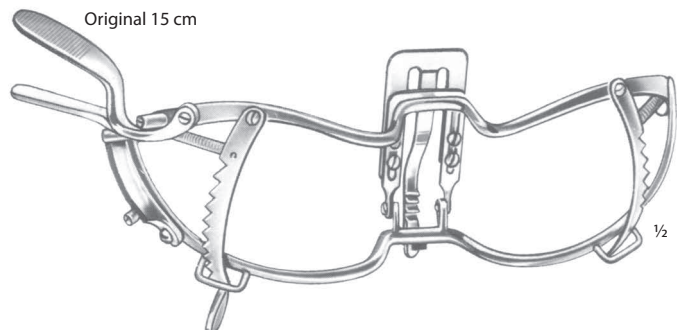

WHITEHEAD
119 91 0194 11,0 cm
119 91 0195 13,0 cm
119 91 0196 15,0 cm

LŽIČKY OBOUSTRANNÉ
BONE CURETTES DOUBLE FACED

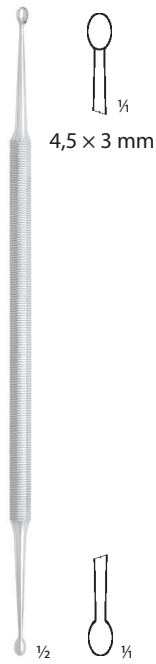

125 50 0010
rovná
straight
17,0 cm

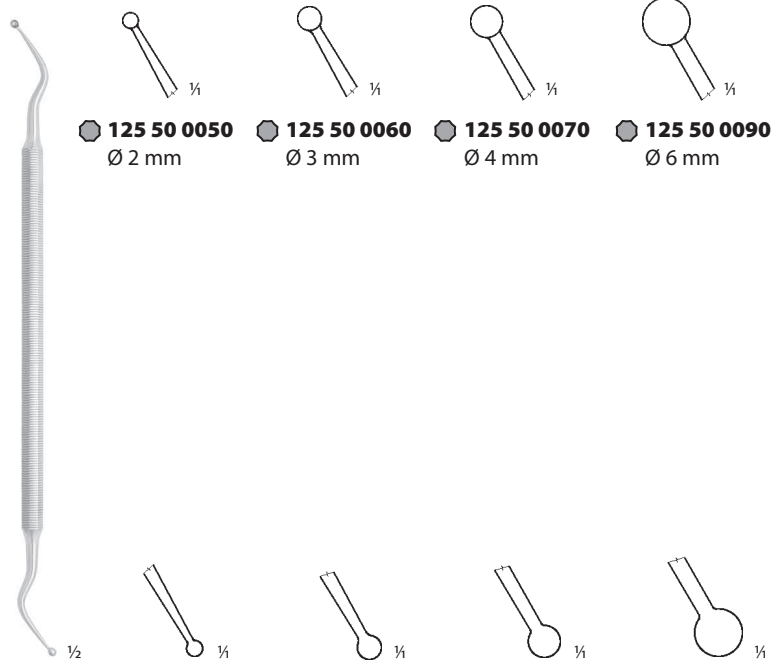

125 50 0050
lomená, ostrá
angled, sharp
17,0 cm

- **125 50 0050**
Ø 2 mm
- **125 50 0060**
Ø 3 mm
- **125 50 0070**
Ø 4 mm
- **125 50 0090**
Ø 6 mm



125 56 0066
lomená, ostrá
angled, sharp
16,7 cm

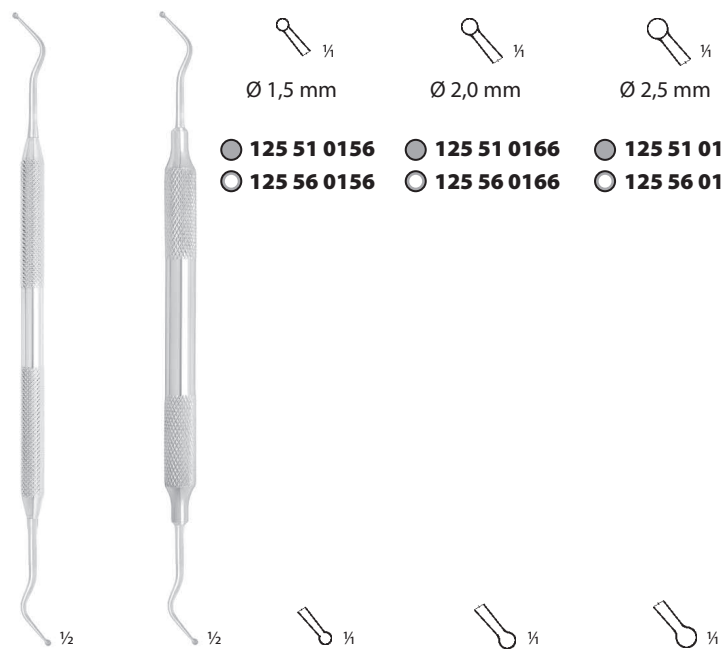

125 51 0156 **125 56 0156**
ostrá ostrá
sharp sharp
16,6 cm 16,6 cm

- **125 51 0156**
- **125 51 0166**
- **125 51 0176**
- **125 56 0156**
- **125 56 0166**
- **125 56 0176**



Original 17,0 cm



125 08 0110
17,0 cm
Fig. 000
3,5 mm



125 08 0120
17,2 cm
Fig. 0
4,8 mm



125 08 0130
17,5 cm
Fig. 1
6,0 mm



125 08 0140
17,7 cm
Fig. 3
8,5 mm



125 08 0150
18,4 cm
Fig. 5
12,0 mm



Original 17,5 cm



125 08 0160
16,5 cm
Fig. 1
3,0 mm



125 08 0170
16,5 cm
Fig. 2
3,5 mm



125 08 0180
17,5 cm
Fig. 3
4,0 mm



125 08 0190
17,5 cm
Fig. 4
5,0 mm



125 08 0200
19,5 cm
Fig. 5
6,0 mm



125 08 0210
19,5 cm
Fig. 6
6,7 mm

LŽIČKY
BONE CURETTES

125 50 0100
pravá
right
16,3 cm

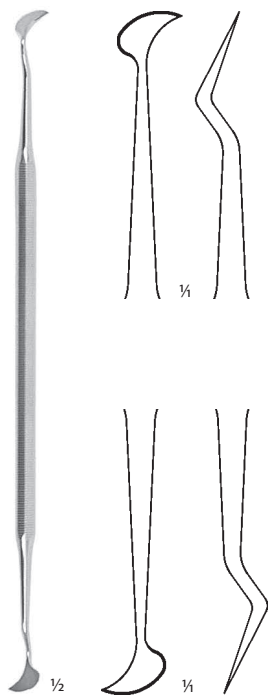

125 50 0110
levá
left
16,3 cm

NOŽE
KNIVES

Nůž na dásněn oboustranný
Gum knife mutual
112 50 0050
18,0 cm

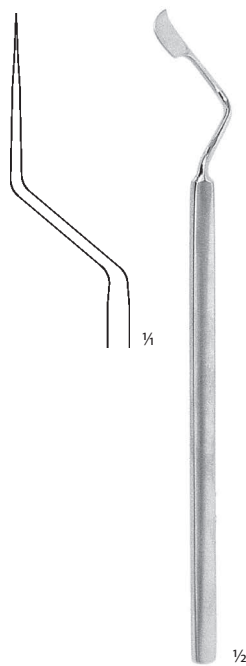

Nůž na gingivektomii
Gingivectomy knife
112 50 0060
17,3 cm
Fig. 1

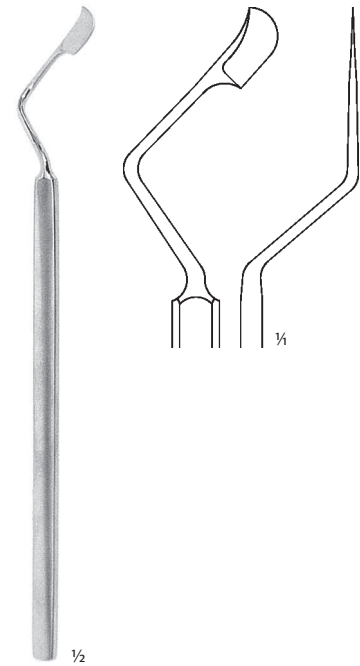

Nůž na gingivektomii
Gingivectomy knife
112 50 0070
17,3 cm
Fig. 2

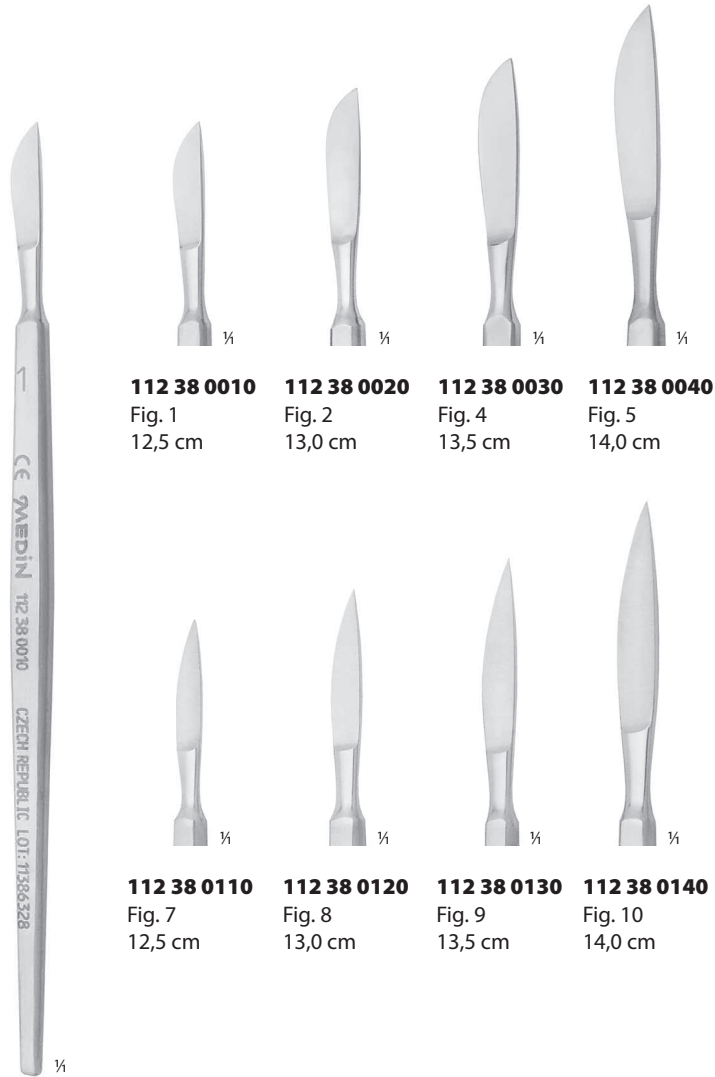

112 38 0010
Fig. 1
12,5 cm

112 38 0020
Fig. 2
13,0 cm

112 38 0030
Fig. 4
13,5 cm

112 38 0040
Fig. 5
14,0 cm

112 38 0110
Fig. 7
12,5 cm

112 38 0120
Fig. 8
13,0 cm

112 38 0130
Fig. 9
13,5 cm

112 38 0140
Fig. 10
14,0 cm

DIEFFENBACH
12,5 cm



112 91 0002
12,3 cm
Fig. 3



112 91 0003
12,3 cm
Fig. 3



112 91 0004
13,3 cm
Fig. 4



112 91 0005
20,5 cm
Fig. 3L

SKALPELOVÉ ČEPELKY STERILNÍ PRO VELIKOST DRŽÁTKA 3
SCALPEL BLADES STERILE FOR HANDLE SIZE 3

pro držátka
for handles

112 91 0002
112 91 0003
112 91 0005
112 91 0007
112 91 0008



112 91 0010
Fig. 10



112 91 0011
Fig. 11



112 91 0012
Fig. 12



112 91 0025
Fig. 12d



112 91 0013
Fig. 13



112 91 0015
Fig. 15



112 91 0026
Fig. 15c

POZNÁMKY: sterilní, balení 100 ks
NOTES: sterile, packing 100 pcs

SKALPELOVÉ ČEPELKY STERILNÍ PRO VELIKOST DRŽÁTKA 4
SCALPEL BLADES STERILE FOR HANDLE SIZE 4

pro držátka
for handles

112 91 0004
112 91 0006
112 08 0650



112 91 0018
Fig. 18



112 91 0020
Fig. 20



112 91 0021
Fig. 21



112 91 0022
Fig. 22



112 91 0023
Fig. 23



112 91 0024
Fig. 24



112 91 0027
Fig. 25

POZNÁMKY: sterilní, balení 100 ks
NOTES: sterile, packing 100 pcs

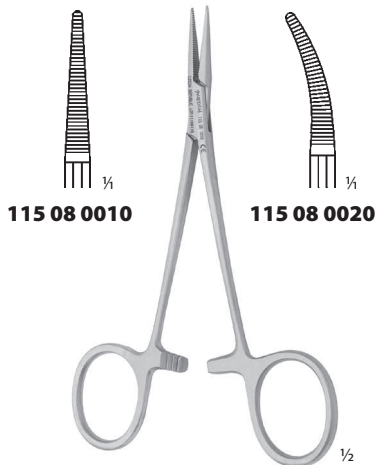

MOSQUITO-HALSTED
standard
standard
12,0 cm

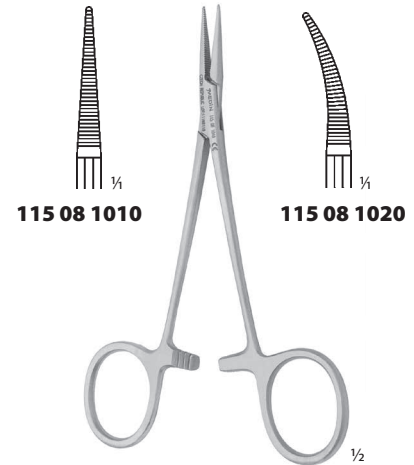

MOSQUITO-HALSTED
jemné
fine
12,0 cm

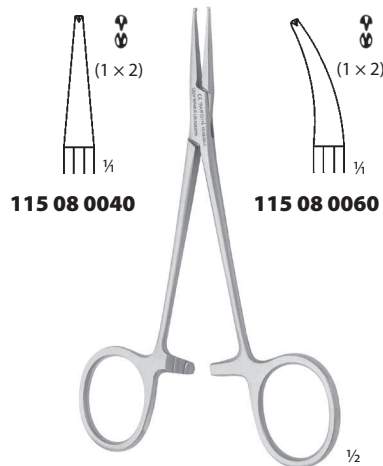

MOSQUITO-HALSTED
hladká čelist
smooth jaw
12,0 cm

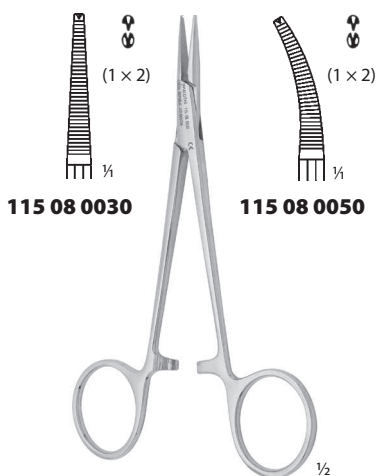

MOSQUITO-HALSTEAD
standard
standard
12,0 cm

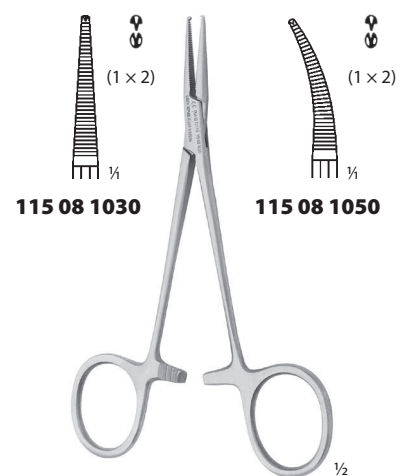

MOSQUITO-HALSTEAD
jemné
fine
12,0 cm

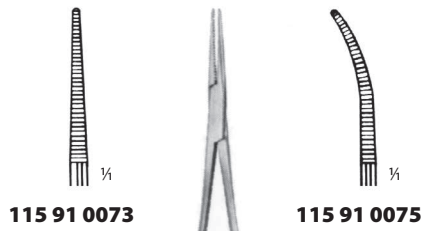

MICRO-MOSQUITO
12,0 cm

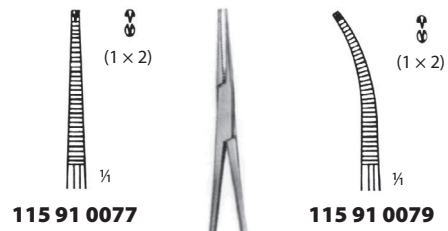

MICRO-MOSQUITO
12,0 cm

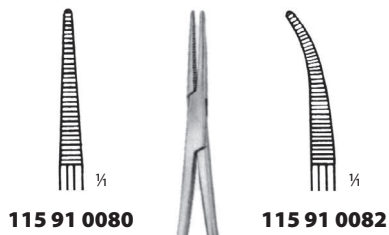

HALSTEAD-MOSQUITO
12,5 cm

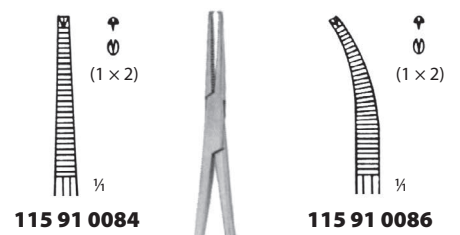

HALSTEAD-MOSQUITO
12,5 cm

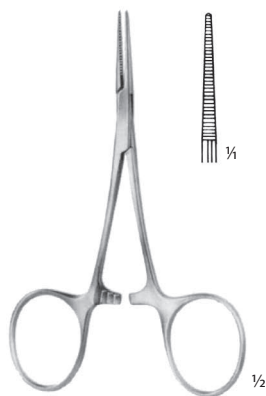

HARTMANN
115 91 0068
10,0 cm

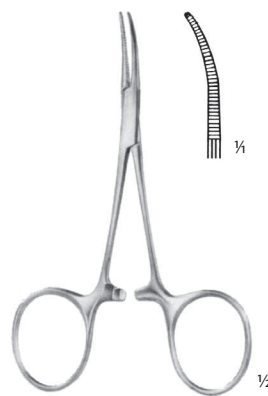

HARTMANN
115 91 0069
10,0 cm

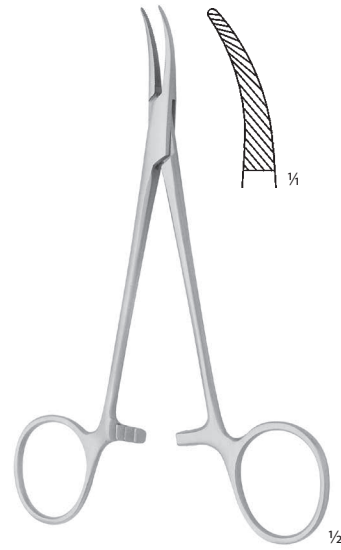
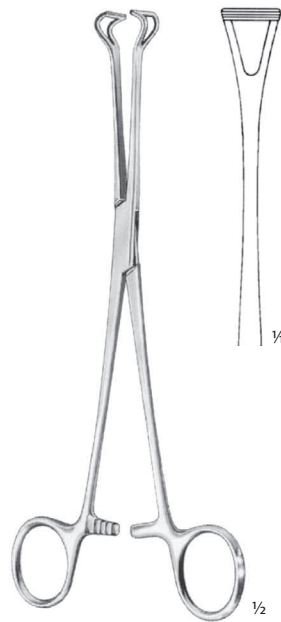
SVORKY NA CÉVY
ARTERY FORCEPS**ROCHESTER-PEAN**
115 08 0260zahnutá
curved
14,0 cm**KELLY**
115 08 0500zahnutá
curved
14,0 cmSVORKA CHIRURGICKÁ
TISSUE FORCEPS**BABCOCK**
115 91 0382

16,0 cm



DE BAKEY

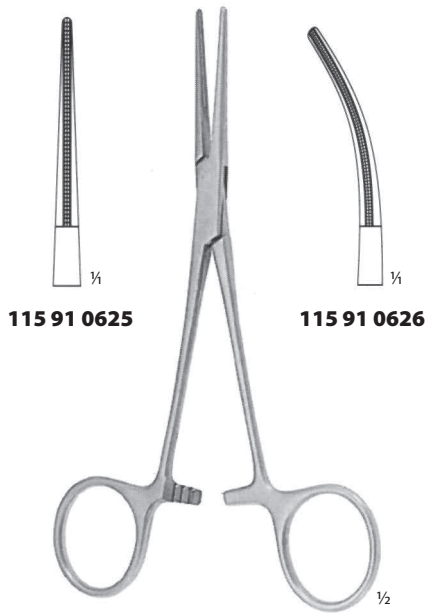

115 91 0625

115 91 0626

DE BAKEY-RANKIN
16,0 cm

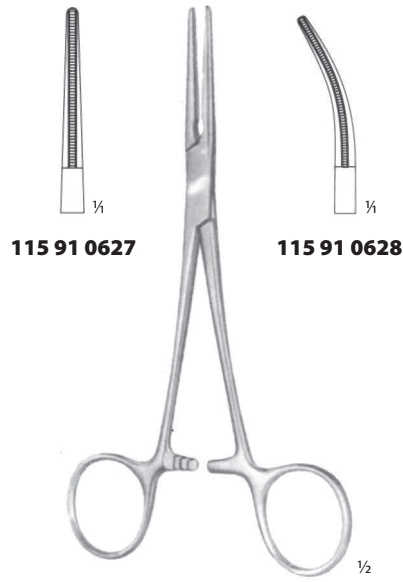

115 91 0627

115 91 0628

DE BAKEY-MOSQUITO
15,0 cm



115 91 0596

115 91 0629

DE BAKEY-MOSQUITO
12,0 cm



DE BAKEY-PEAN

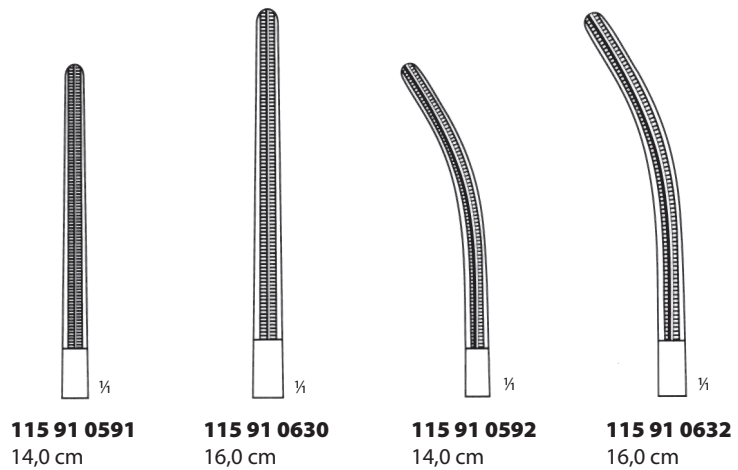

115 91 0591
14,0 cm

115 91 0630
16,0 cm

115 91 0592
14,0 cm

115 91 0632
16,0 cm

SVORKY NA PRÁDLO
TOWEL FORCEPS

BACKHAUS
115 08 0780
11,8 cm



BACKHAUS
115 08 0790
12,0 cm



BACKHAUS-CLIP
115 91 0341
11,0 cm



BACKHAUS
115 91 0343 11,0 cm
115 91 0345 15,0 cm

Original 15,0 cm



BACKHAUS
115 08 0810 8,0 cm
115 08 0820 13,0 cm

Original 13,0 cm



ROEDER
115 91 0348 13,0 cm
115 91 0349 15,0 cm

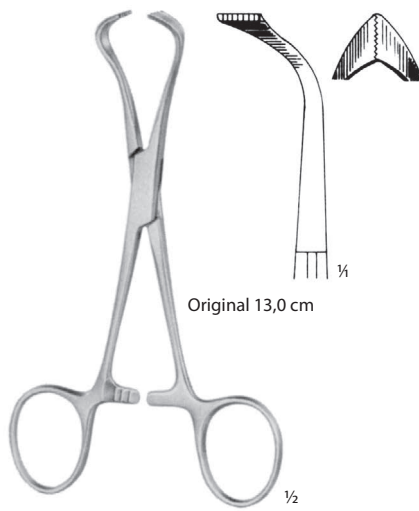

LORNA
115 91 0350 10,0 cm
115 91 0351 13,0 cm

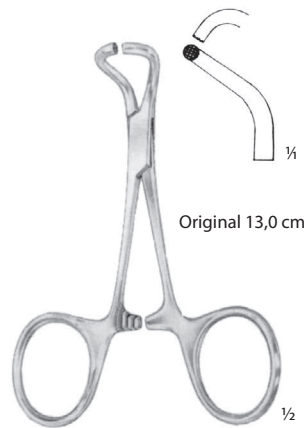

TOHOKU-JAPAN
115 91 0352 10,0 cm
115 91 0353 13,0 cm

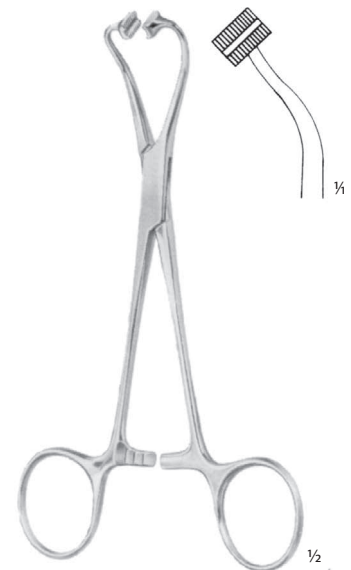

PEERS
115 91 0354 14,5 cm

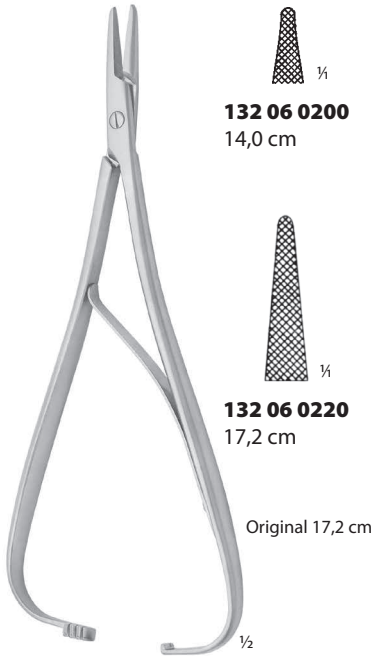

MATHIEU

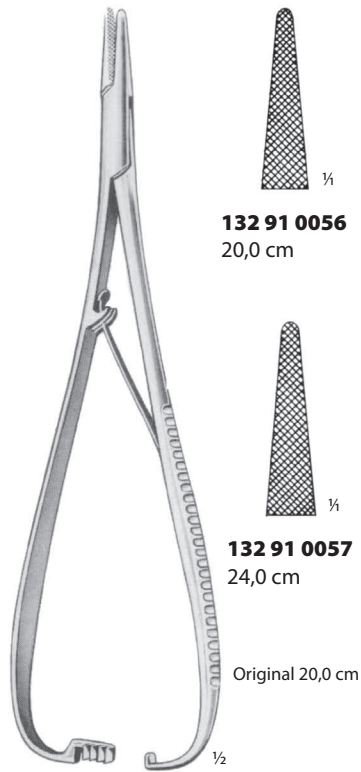
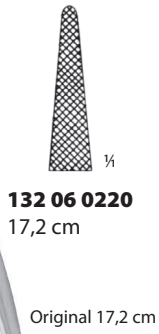

MATHIEU

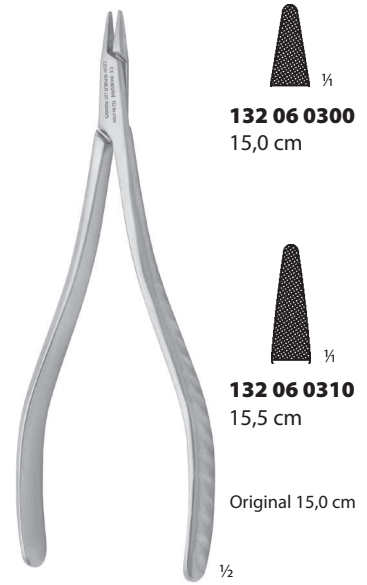
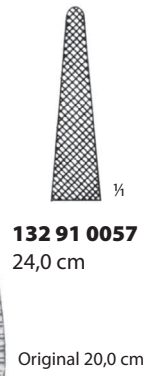

CRILE





OLSEN-HEGAR

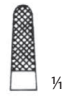

132 91 0160
14,0 cm

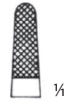

132 91 0161
17,0 cm



132 91 0162
19,0 cm



132 06 0610
16,5 cm



RYDER/FRENCH-EYE
132 06 0650
25,5 cm



132 06 0600
16,5 cm



132 06 0640
20,5 cm

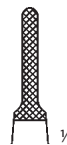

132 06 0650
25,5 cm



MATHIEU
132 06 0520
14,0 cm



MATHIEU
132 06 0500
17,2 cm



MATHIEU
132 06 0510
21,5 cm



MATHIEU

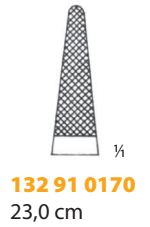

BOYNTON
132 91 0182
12,0 cm



CRILE
132 06 0370
15,7 cm



CRILE
132 06 0450
16,2 cm

JEHELCE TVRDOKOVOVÉ
NEEDLE HOLDERS WITH TUNGSTEN CARBIDE INSERT

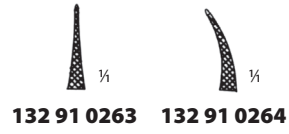
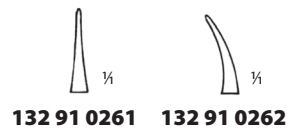

CASTROVIEJO
14,0 cm

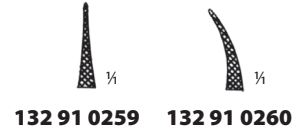
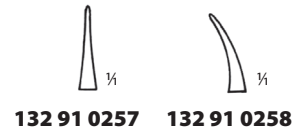

CASTROVIEJO
14,0 cm

MIKRO JEHELCE TVRDOKOVOVÉ
MICRO-NEEDLE HOLDERS WITH TUNGSTEN CARBIDE INSERT

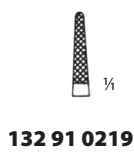

CASTROVIEJO
18,0 cm

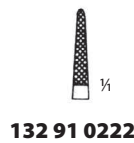
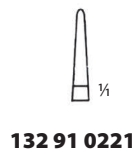
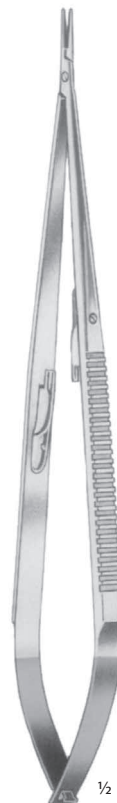

JACOBSON
21,0 cm

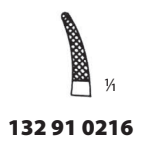
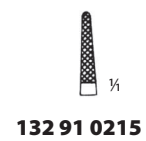

CASTROVIEJO
14,0 cm

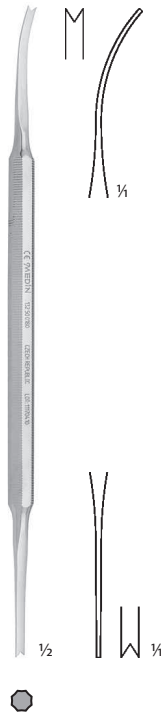
ZAVADĚČE DRENŮ
DRAIN INTRODUCERS

LUNIATSCHEK
132 50 0180
17,0 cm



LUNIATSCHEK
132 50 0186
16,8 cm



LUNIATSCHEK
132 56 0186
16,8 cm



LUNIATSCHEK
132 50 0196
žlábkový
grooved
16,8 cm



LUNIATSCHEK
132 56 0196
žlábkový
grooved
16,8 cm

○ osmihranné držátko – octagonal handle 5,5 mm ○ plné držátko – round solid handle Ø 6,0 mm ○ duté držátko – hollow handle Ø 8,0 mm

DLAHA PREFABRIKOVANÁ
PREFABRICATED PLATE

129 51 0100
15,2 cm



LISTER
113 05 0030
15,0 cm



LISTER
113 05 0040
20,0 cm

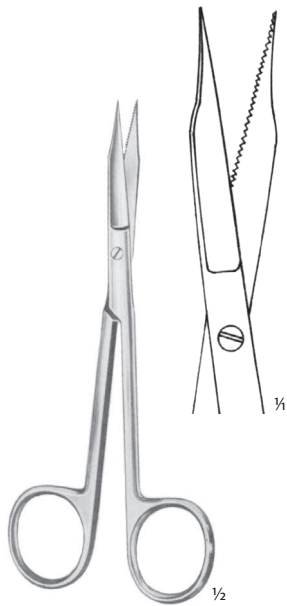

GOLDMANN-FOX
113 91 0474
se zuby, rovné
saw edge, straight
13,0 cm

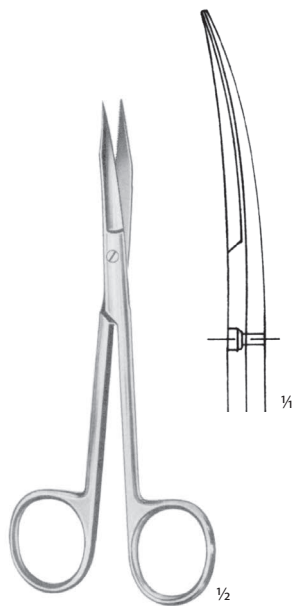

GOLDMANN-FOX
113 91 0475
se zuby, zahnuté
saw edge, curved
13,0 cm

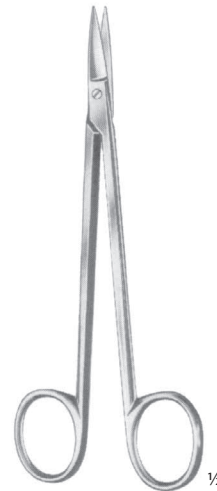

QUINBY
113 91 0483
rovné
straight
12,0 cm

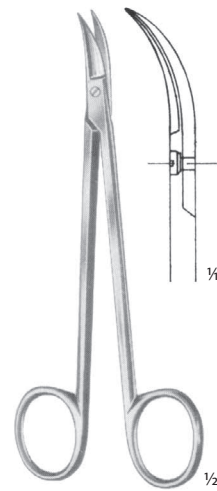

QUINBY
113 91 0484
zahnuté
curved
12,0 cm

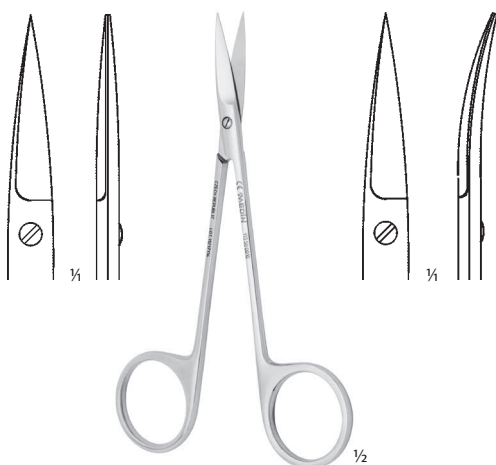

113 50 0010
rovné
straight
12,0 cm

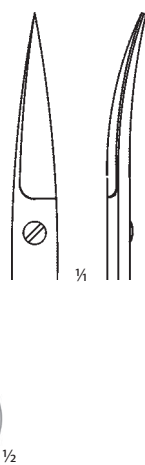

113 50 0020
zahnuté
curved
12,0 cm



113 50 0030
rovné
straight
14,5 cm

113 50 0040
zahnuté
curved
14,5 cm



SANVENERO
113 91 0221
rovné
straight
14,0 cm

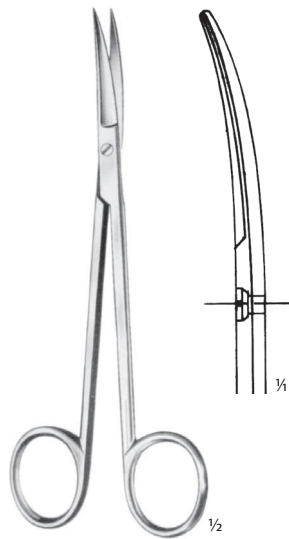

SANVENERO
113 91 0222
zahnuté
curved
14,0 cm



REYNOLDS
113 91 0233
rovné
straight
15,0 cm

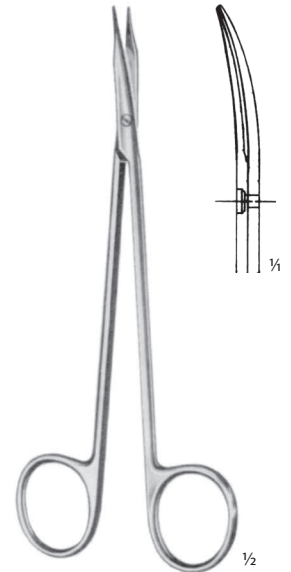

REYNOLDS
113 91 0235
zahnuté
curved
15,0 cm

NŮŽKY PRO LIGATURU
LIGATURE SCISSORS



SPENCER
113 91 0399 **113 91 0400**
9,0 cm 10,5 cm



LITTAUER
113 91 0403
14,0 cm

NŮŽKY CHIRURGICKÉ
OPERATING SCISSORS

Original 15 cm

STANDARD
hrotnaté rovné
sharp straight

113 08 0010 13,0 cm
113 08 0020 15,0 cm
113 08 0040 18,5 cm
113 08 0060 22,0 cm
113 08 0070 30,0 cm

1/2



Original 15 cm

STANDARD
hrotnaté zahnuté
sharp curved

113 08 0310 13,0 cm
113 08 0320 15,0 cm
113 08 0340 18,5 cm
113 08 0360 22,0 cm
113 08 0370 30,0 cm

1/2



Original 15 cm

STANDARD
hrotnatotupé rovné
sharp-blunt straight

113 08 0110 13,0 cm
113 08 0120 15,0 cm
113 08 0140 18,5 cm
113 08 0160 22,0 cm
113 08 0170 30,0 cm

1/2



Original 15 cm

STANDARD
hrotnatotupé zahnuté
sharp-blunt curved

113 08 0410 13,0 cm
113 08 0420 15,0 cm
113 08 0440 18,5 cm
113 08 0460 22,0 cm
113 08 0470 30,0 cm

1/2



Original 15 cm

STANDARD
tupé rovné
blunt straight

113 08 0210 13,0 cm
113 08 0220 15,0 cm
113 08 0240 18,5 cm
113 08 0260 22,0 cm
113 08 0270 30,0 cm

1/2



Original 15 cm

STANDARD
tupé zahnuté
blunt curved

113 08 0510 13,0 cm
113 08 0520 15,0 cm
113 08 0540 18,5 cm
113 08 0560 22,0 cm
113 08 0570 30,0 cm

1/2



Original 16,5 cm

STANDARD
hrotnaté rovné
sharp straight

113 91 0042 11,5 cm
113 91 0046 16,5 cm
113 91 0049 20,0 cm



Original 16,5 cm

STANDARD
hrotnaté zahnuté
sharp curved

113 91 0051 11,5 cm
113 91 0055 16,5 cm
113 91 0058 20,0 cm



Original 16,5 cm

STANDARD
hrotnatotupé rovné
sharp-blunt straight

113 91 0020 11,5 cm
113 91 0026 16,5 cm
113 91 0029 20,0 cm



Original 16,5 cm

STANDARD
hrotnatotupé zahnuté
sharp-blunt curved

113 91 0031 11,5 cm
113 91 0037 16,5 cm
113 91 0040 20,0 cm



Original 16,5 cm

STANDARD
tupé rovné
blunt straight

113 91 0002 11,5 cm
113 91 0006 16,5 cm
113 91 0009 20,0 cm



Original 16,5 cm

STANDARD
tupé zahnuté
blunt curved

113 91 0011 11,5 cm
113 91 0015 16,5 cm
113 91 0018 20,0 cm



WAGNER
113 91 0328
jemné rovné
fine straight
12,0 cm

WAGNER
113 91 0331
jemné zahnuté
fine curved
12,0 cm

WALTON
113 91 0348
10,0 cm

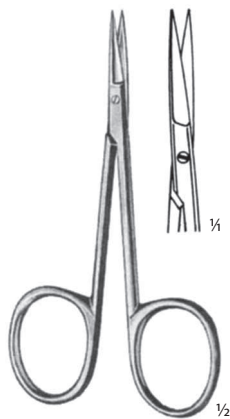

MOD. BONN
113 91 0349
extra jemné
extra delicate
8,0 cm

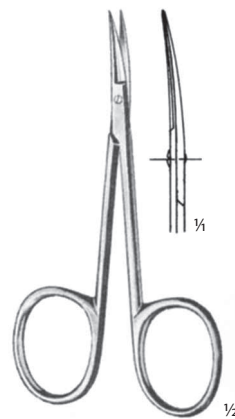

MOD. BONN
113 91 0350
extra jemné
extra delicate
8,0 cm



113 38 0010
113 38 0071
hrotnaté rovné
sharp straight



113 38 0040
113 38 0091
hrotnaté zahnuté
sharp curved

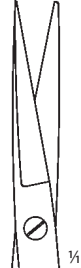

113 38 0020
113 38 0150
hrotnatotupé rovné
sharp-blunt straight



113 38 0050
113 38 0100
hrotnatotupé zahnuté
sharp-blunt curved



113 38 0030
113 38 0081
tupé rovné
blunt straight



113 38 0060
113 38 0161
tupé zahnuté
blunt curved



113 38 0210
hrotnaté
sharp
10,5 cm

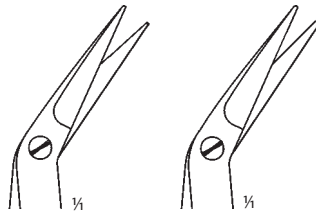

113 38 0260
tupé
blunt
10,5 cm



113 38 0311
11,5 cm

NŮŽKY OČNÍ
EYE SCISSORS



NOYES
12,0 cm



113 91 0490



113 91 0492



113 91 0494

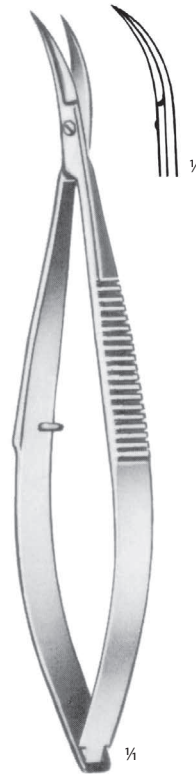

CASTROVIEJO
113 91 0507
10,0 cm

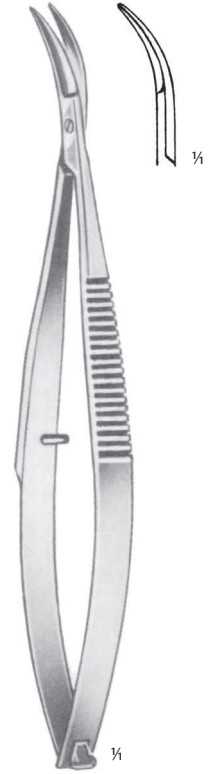

CASTROVIEJO
113 91 0508
10,0 cm

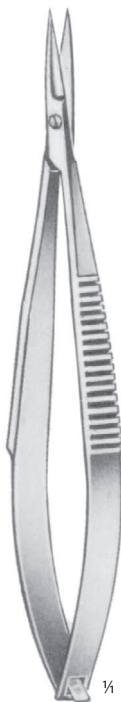

CASTROVIEJO
113 91 0502
9,0 cm



113 91 0503

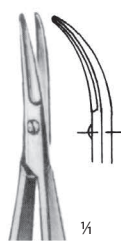

113 38 1020



113 91 0505



113 38 1030



GOMEL
14,5 cm

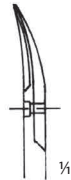

113 91 0537



113 91 0539



GOMEL
18,0 cm

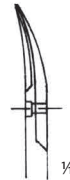

113 91 0538



113 91 0540



18,5 cm



113 91 0552



113 91 0553

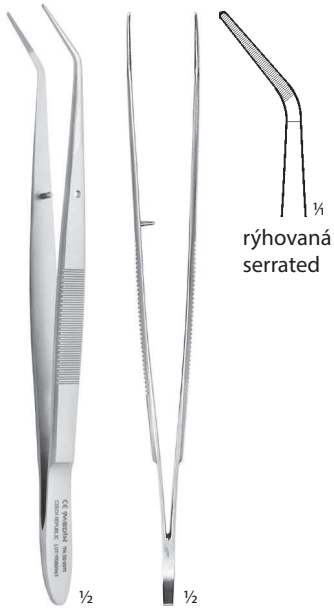

114 50 0011
zahnutá
curved
15,7 cm

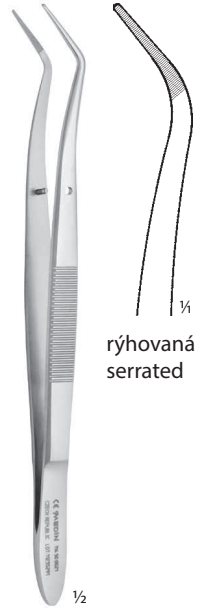

114 50 0021
lomená
angled
15,7 cm



114 50 0031
lomená
angled
15,7 cm



114 50 1030
lomená
angled
15,7 cm



114 50 0051
15,7 cm



114 50 0150
zahnutá, jemná
curved, fine
14,2 cm



114 50 0170
zahnutá
curved
15,7 cm



114 08 0090
14,5 cm



114 08 0101
jemná
fine
14,5 cm



114 08 0231
velmi jemná
very fine
14,5 cm



114 08 0140
jemná
fine
20,0 cm



114 08 0240
velmi jemná
very fine
20,0 cm



114 08 0250
24,5 cm

PINZETY ANATOMICKÉ
DRESSING FORCEPS

Original 14,5 cm

114 91 0002 **114 91 0003** **114 91 0004** **114 08 0030** **114 91 0006** **114 08 0040** **114 08 0050** **114 08 0060**

114 91 0002	11,5 cm
114 91 0003	13,0 cm
114 91 0004	14,5 cm
114 08 0030	16,0 cm
114 91 0006	18,0 cm
114 08 0040	20,0 cm
114 08 0050	25,0 cm
114 08 0060	30,0 cm

STANDARD 1/2

PINZETY CHIRURGICKÉ
TISSUE FORCEPS

Original 14,5 cm

114 91 0011 **114 91 0012** **114 08 0381** **114 91 0015** **114 08 0340** **114 08 0350** **114 08 0360**

114 91 0011	11,5 cm
114 91 0012	13,0 cm
114 08 0381	14,5 cm
114 91 0015	18,0 cm
114 08 0340	20,0 cm
114 08 0350	25,0 cm
114 08 0360	30,0 cm

STANDARD 1/2



114 08 0430
jemná
fine
16,0 cm



114 08 0530
velmi jemná
very fine
14,5 cm

PINZETY ŠÍČÍ
SUTURING FORCEPS



114 91 0255
12,0 cm



114 91 0257
12,0 cm

114 91 0256
15,0 cm

114 91 0258
15,0 cm

PINZETY TVRDOKOVOVÉ
FORCEPS WITH TUNGSTEN CARBIDE INSERT

OEHLER

(1 × 2)

114 91 0477 14,0 cm

114 91 0478 16,0 cm

114 91 0479 18,0 cm

Original 18,0 cm

114 91 0480 20,0 cm

114 91 0481 25,0 cm

114 91 0482 30,0 cm

ADSON

Original 12,0 cm

(1 × 2)

114 91 0487 12,0 cm

114 91 0490 12,0 cm

114 91 0489 15,0 cm

114 91 0491 15,0 cm

SEMKEN

Original 12,5 cm

114 91 0483 12,5 cm

114 91 0484 15,5 cm

GILLIES

(2 × 1)

114 91 0485 15,0 cm

JEWELER

114 91 0486 15,0 cm

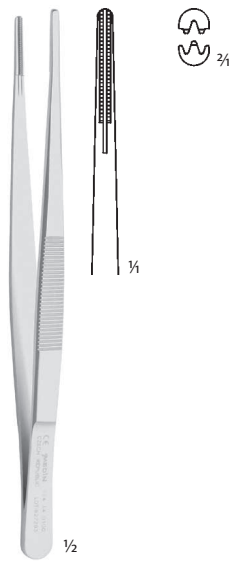

114 14 0100
14,5 cm

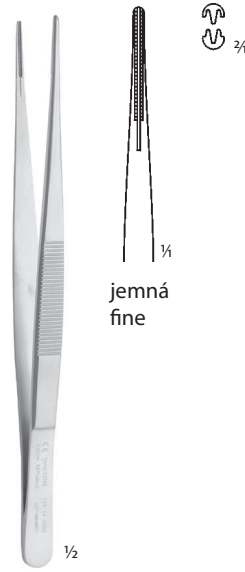

114 14 0300
14,5 cm

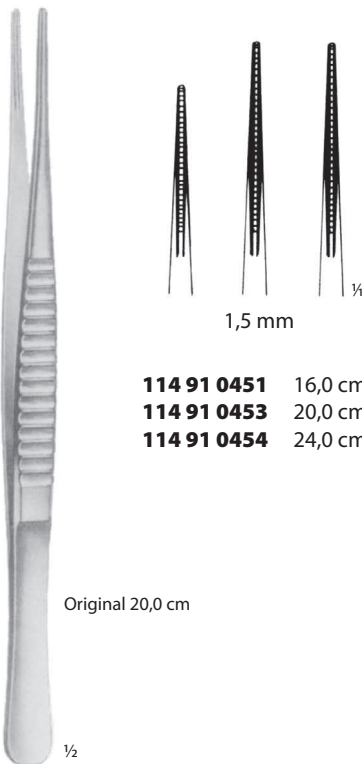

114 91 0451 16,0 cm
114 91 0453 20,0 cm
114 91 0454 24,0 cm

DE BAKEY

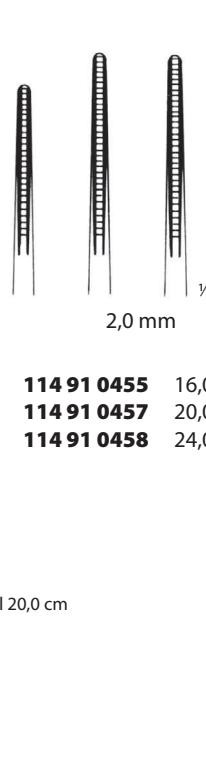

114 91 0455 16,0 cm
114 91 0457 20,0 cm
114 91 0458 24,0 cm

DE BAKEY

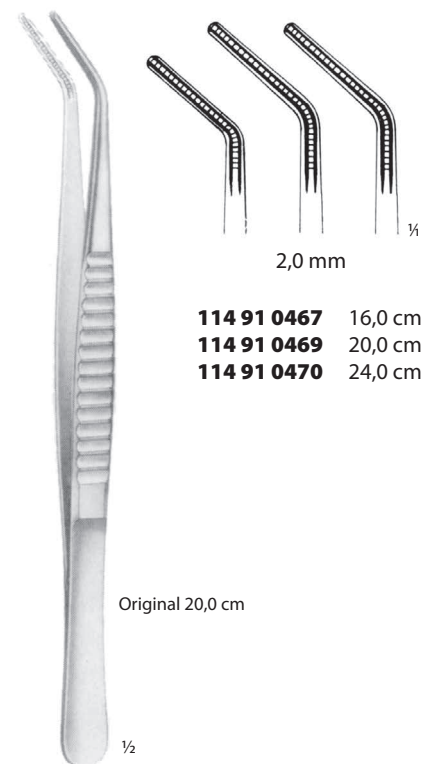

114 91 0467 16,0 cm
114 91 0469 20,0 cm
114 91 0470 24,0 cm

DE BAKEY



GRAEFE
10,5 cm

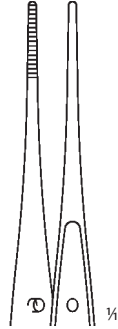

114 38 0010



114 38 0020
jemná
fine



114 38 0150

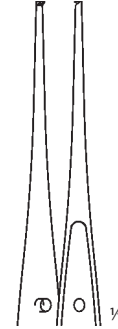

114 38 0160
jemná
fine

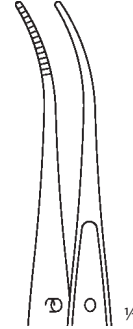

114 38 0100
jemná
fine



se zámkem
with lock

GRAEFE
114 38 0360
11,0 cm